

Basic immunology

**Congenital and acquired
immunodeficiencies**

Groups of immunodeficiencies

I. Congenital

- 1) Phagocyte cell deficiencies
- 2) Complement deficiencies
- 3) Severe combined immunodeficiency syndrome (SCID)
- 4) T – cell deficiencies
- 5) B - cell deficiencies

II. Acquired

- 1) Malignant transformations (tumors, especially diseases of the hematopoietic system)
- 2) Systemic diseases (autoimmune disease, sarcoidosis)
- 3) Infectious diseases/AIDS
- 4) Medication caused immunosuppression (autoimmune diseases, transplantation)
- 5) Malnutrition
- 6) Burn

General clinical symptoms

- **Recurrent infections**
- **Skin and mucosa inflammation**
- **Chronic diarrhea**
- **Tiredness**
- **Hepato-splenomegaly**
- **Autoimmunity**
- **Chronic osteomyelitis**

Diagnosics

- Anamnesis, focusing on infections
- Familiar anamnesis for inborn defects
- Body height, weight, development
- Response for vaccination
- Labordiagnosics:
Tests for T- , B - , NK-cell and neutrophil functions,
Complement-assay
- Genetic background

Groups of congenital immunodeficiencies

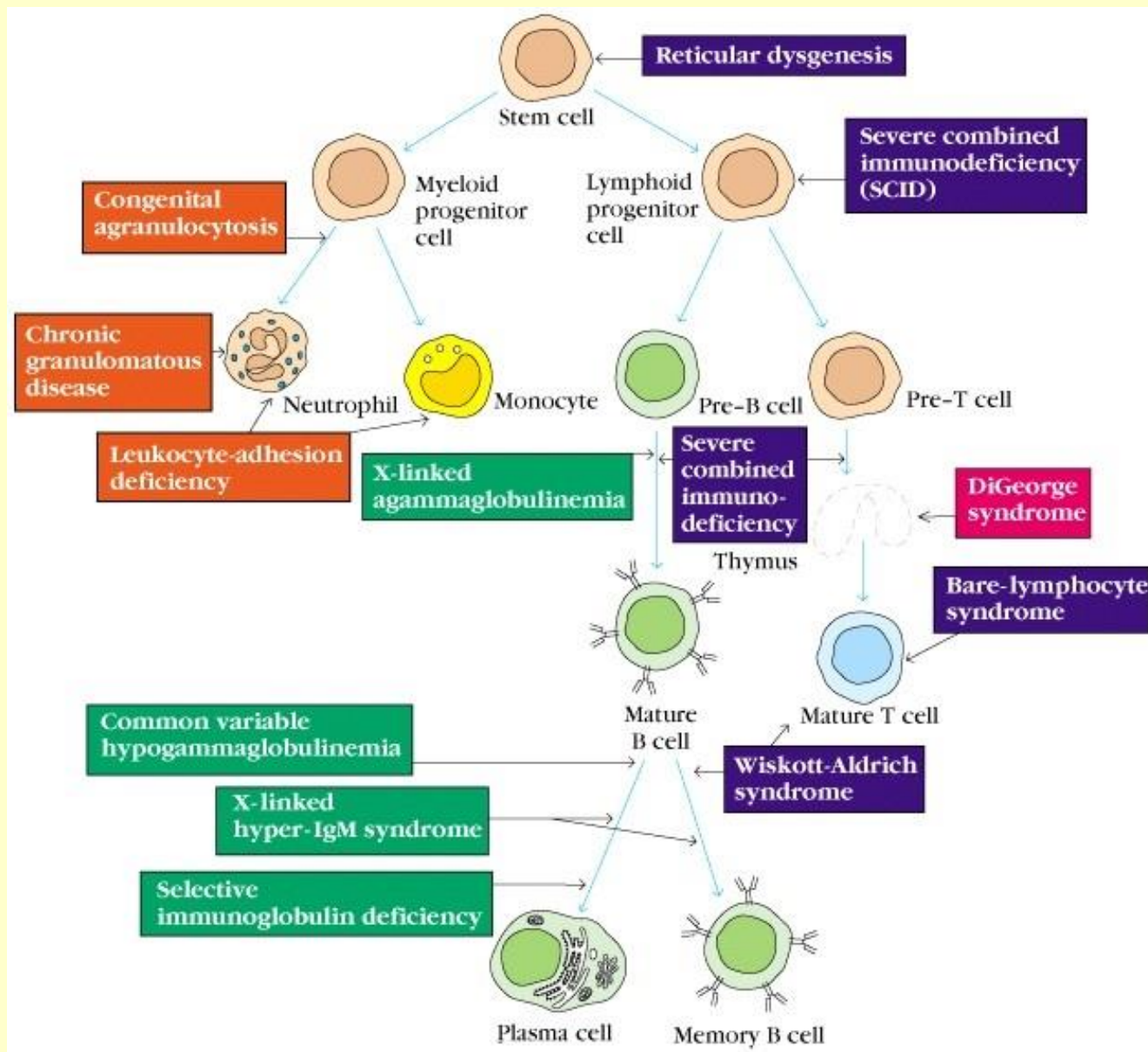

Innate immune deficiencies

B – cell deficiencies

T- and B - cell deficiencies

T – cell deficiencies

Most frequent immunodeficiencies of innate immunity

- Granulocyte/monocyte granulum- defects
- Intracellular killing defects
- Chemotaxis, adhesion defects (LAC)
- PAMP/TLR- defects
- NK-cell defects
- Complement-deficiencies

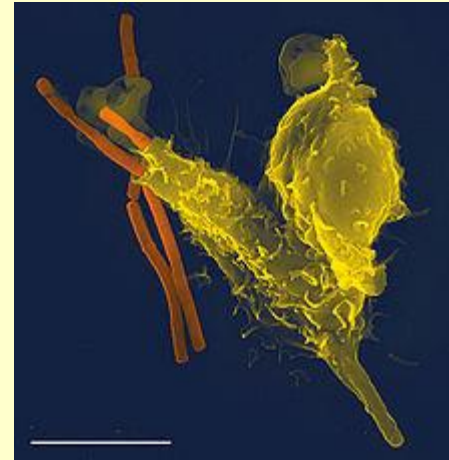

Most frequent immunodeficiencies of adaptive immunity

- Usually recessive genetic diseases
- X –linked diseases

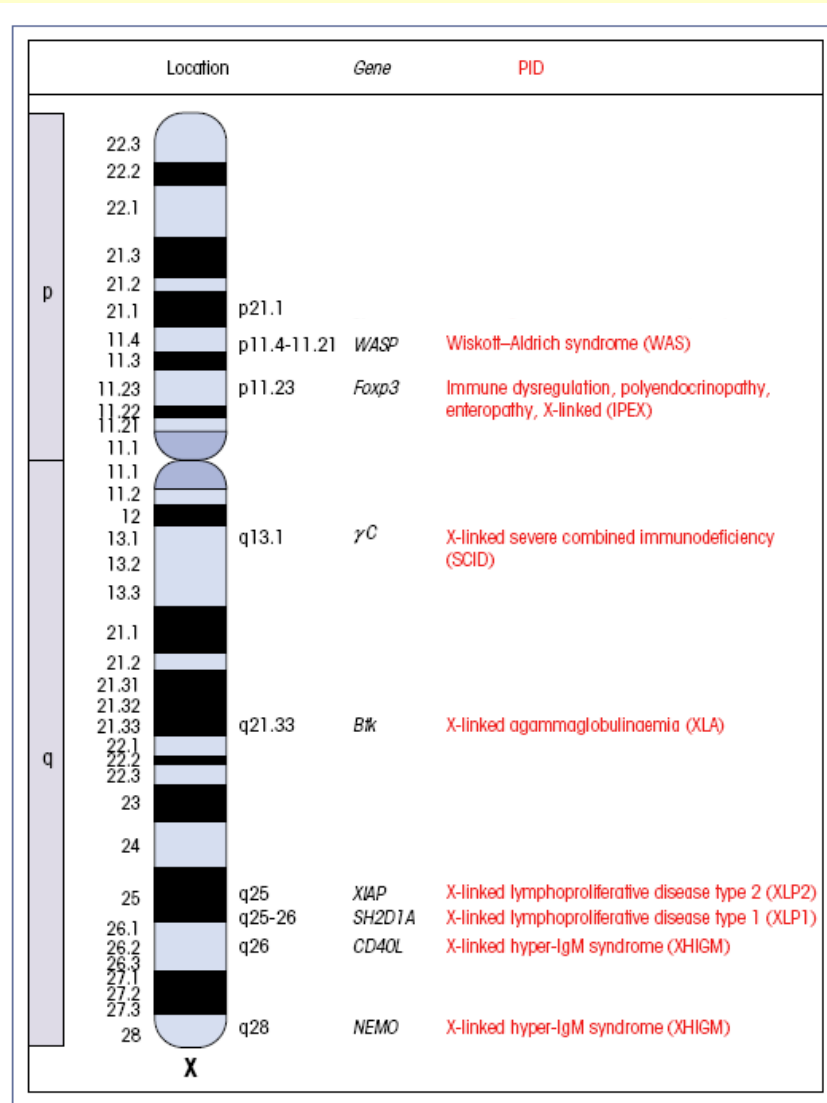

Sever combined immunodeficiencies (SCID)

- **T- and B-cell defects**
- **Higher risks for infection in 3-6 months old**
- **In SCID the skin, airways and gastrointestinal tracts are affected**
- **The thymus, lymph nodes, tonsilles are not detectable**

Background of SCID

- **Defects of Enzymes involved in nucleotide synthesis (ADA – adenosindesaminase, PNP – purinnucleotidephosphorilase)**
- **X-linked defects – defects of common cytokine receptor gamma chain (IL-2, IL-4, IL-7, IL-9, IL-15)**
- **Autosomal SCID – DNA repair defects**
- **RAG-1-, RAG-2- deficiency (Omenn's syndrome)**
- **ZAP-70- deficiency**

SCID

Normal

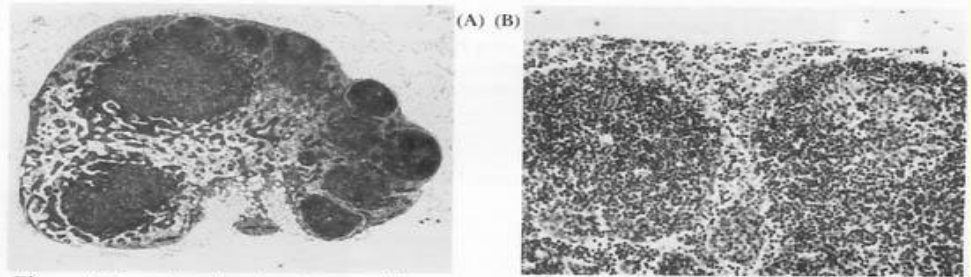
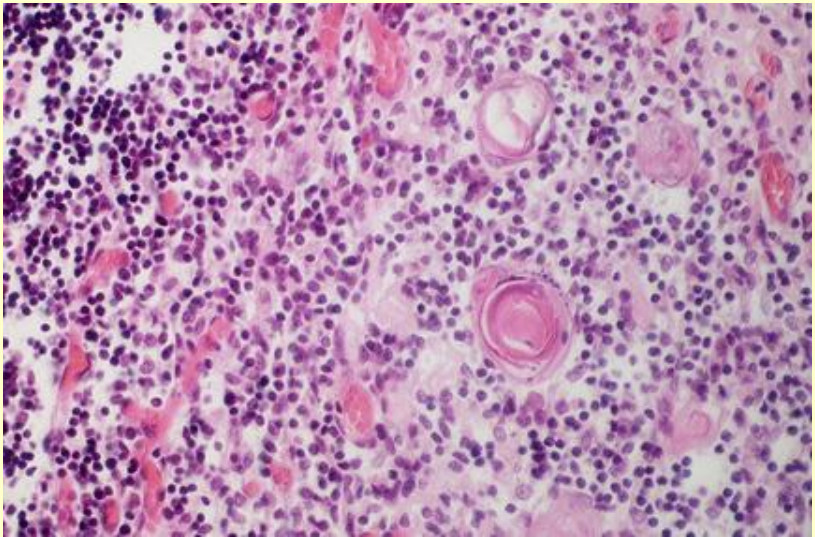
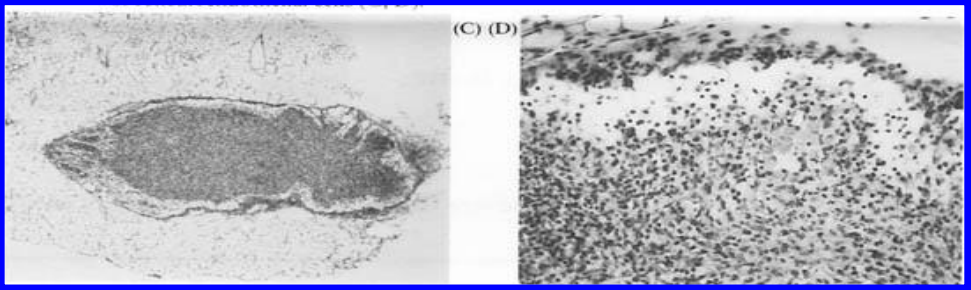
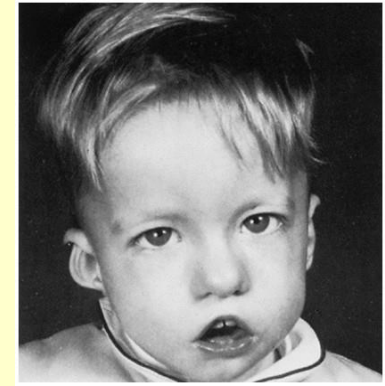

Figure 1 Lymph node of a +/+ control has numerous, prominent follicles with germinal centers (A, B) while the *scid/scid* littermate has only a small, rudimentary lymph node consisting

SCID



DiGeorge- syndrome



- The embryological defects of 3. and 4. pharyngeal arches
- Embryological defects of thymus epithel
- Developmental defects of other organs (parathyroids)
- Defects in T-cell development
- Defects of T- dependent antibody production
- Defects of cellular immune response
- „Nude” micemodell

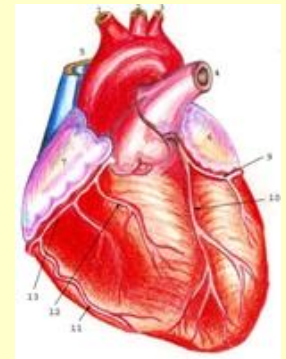

B- cell deficiencies

X-linked

Hyper-IgM syndrome

- Defects of CD40 ligand,
- No isotype switch

X-linked

Agammaglobulinaemia

- Few B cells
- Defects of Btk

(Bruton tyrosine kinase)

Selektive IgA deficiency

- MHC-coupled, no IgA synthesis,
- Airway infections,
- Frequency: 1/400!

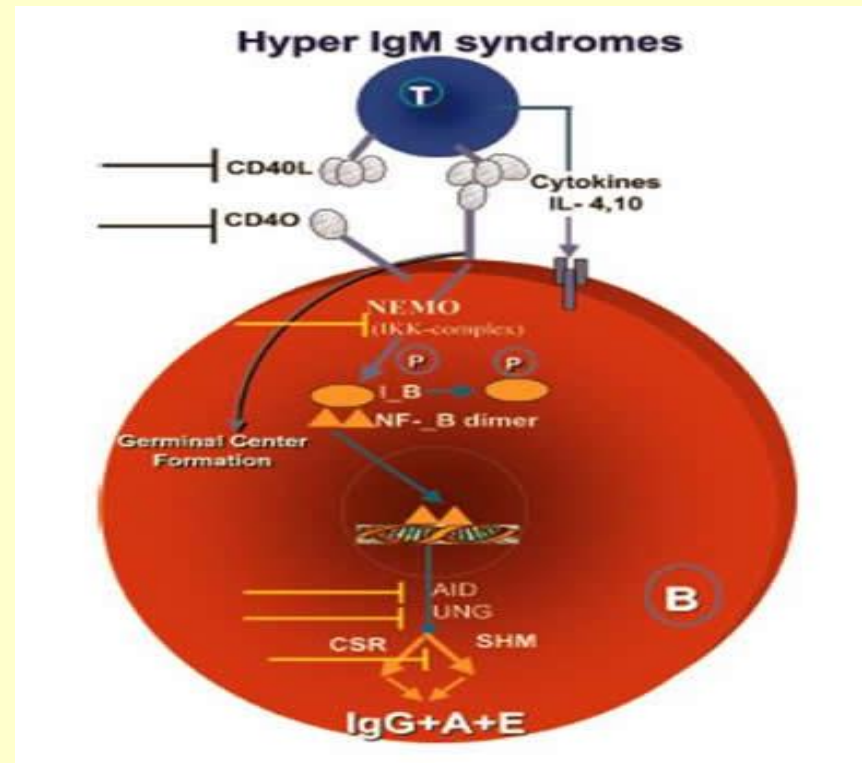

II. Secondary immunodeficiencies

HIV-AIDS

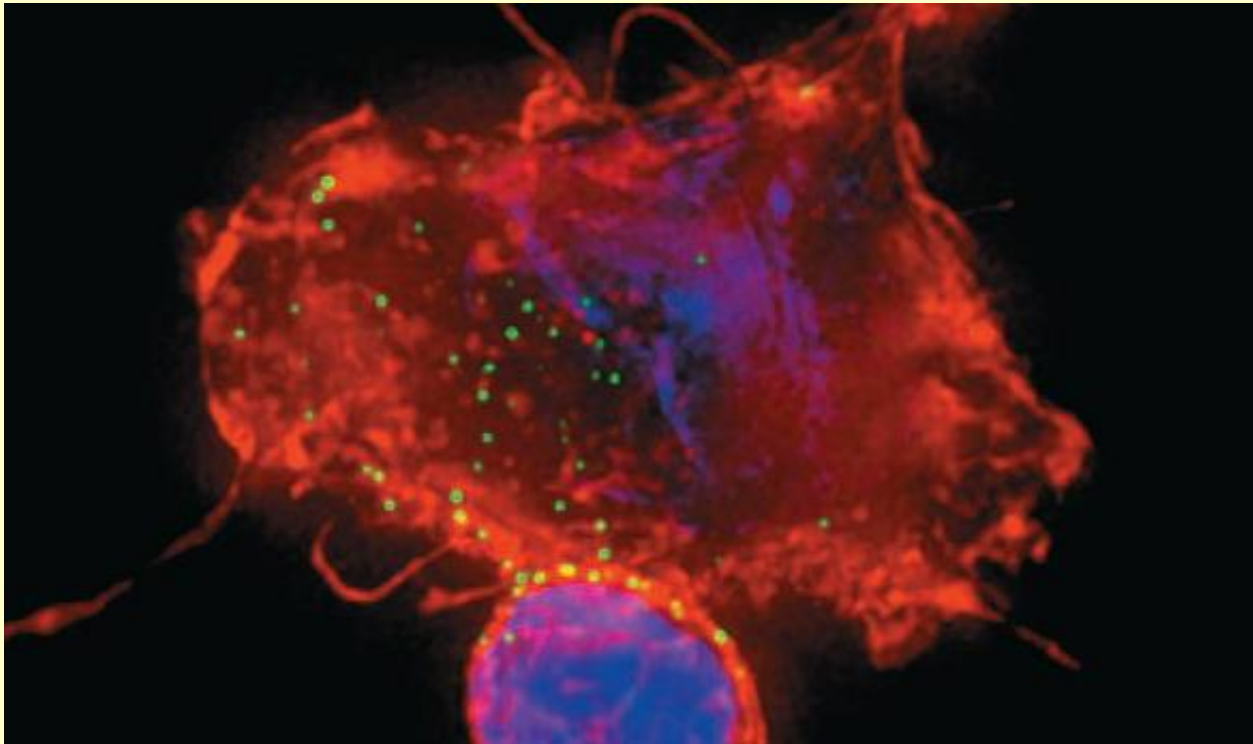

Epidemics (WHO)

	2000	2005	2010	2015	2016	2017	2018	2019	2020/ *june2021	2023
People living with HIV	25.5 million [20.5 million– 30.7 million]	28.6 million [23.0 million– 34.3 million]	31.1 million [25.0 million– 37.3 million]	34.6 million [27.7 million– 41.4 million]	35.3 million [28.3 million– 42.2 million]	35.9 million [28.8 million– 43.0 million]	36.6 million [29.3 million– 43.8 million]	37.2 million [29.8 million– 44.5 million]	37.7 million [30.2 million– 45.1 million]	39 Million (33.1-45.7 M)
New HIV infections (total)	2.9 million [2.0 million– 3.9 million]	2.4 million [1.7million– 3.4 million]	2.1 million [1.5 million– 2.9 million]	1.8 million [1.3 million– 2.4 million]	1.7 million [1.2 million– 2.4 million]	1.7 million [1.2 million– 2.3 million]	1.6 million [1.1 million– 2.2 million]	1.5 million [1.1 million– 2.1 million]	1.5 million [1.0 million– 2.0 million]	1.3 million (1.0-1.7)
New HIV infections (aged 15+ years)	2.3 million [1.6 million– 3.2 million]	2.0 million [1.4 million– 2.7 million]	1.8 million [1.3 million– 2.5 million]	1.6 million [1.1 million– 2.2 million]	1.5 million [1.1 million– 2.1 million]	1.5 million [1.0 million– 2.1 million]	1.4 million [1.0 million– 2.0 million]	1.4 million [960 000– 1.9 million]	1.3 million [910 000– 1.8 million]	1.2 million
New HIV infections (aged 0–14 years)	520 000 [340 000– 820 000]	480 000 [310 000– 750 000]	320 000 [210 000– 510 000]	190 000 [130 000– 300 000]	190 000 [120 000– 290 000]	180 000 [120 000– 280 000]	170 000 [110 000– 260 000]	160 000 [100 000– 250 000]	150 000 [100 000– 240 000]	130 000
AIDS-related deaths	1.5 million [1.1 million– 2.2 million]	1.9 million [1.3 million– 2.7 million]	1.3 million [910 000– 1.9 million]	900 000 [640 000– 1.3 million]	850 000 [600 000– 1.2 million]	800 000 [570 000– 1.2 million]	750 000 [530 000– 1.1 million]	720 000 [510 000– 1.1 million]	680 000 [480 000– 1.0 million]	630 000
People accessing antiretroviral therapy	560 000 [560 000– 560 000]	2.0 million [2.0 million– 2.0 million]	7.8 million [6.9 million– 7.9 million]	17.1 million [14.6 million– 17.3 million]	19.3 million [16.6 million– 19.5 million]	21.5 million [19.6 million– 21.7 million]	23.1 million [21.9 million– 23.4 million]	25.5 million [24.5 million– 25.7 million]	27.5 million [26.5 million– 27.7 million] / *28.2 million	29.8 million
HIV resources available**	US\$ 5.1 billion	US\$ 9.3 billion	US\$ 16.6 billion	US\$ 20.3 billion	US\$ 20.7 billion	US\$ 22.3 billion	US\$ 22.0 billion	US\$ 21.6 billion	US\$ 21.5 billion	20.8 Billion

Regional statistics (WHO – 2018 Dec)

Regional HIV and AIDS statistics and features | 2018

	Adults and children living with HIV	Adults and children newly infected with HIV	Adult and child deaths due to AIDS
Eastern and southern Africa	20.6 million [18.2 million–23.2 million]	800 000 [620 000–1.0 million]	310 000 [230 000–400 000]
Western and central Africa	5.0 million [4.0 million–6.3 million]	280 000 [180 000–420 000]	160 000 [110 000–230 000]
Middle East and North Africa	240 000 [160 000–390 000]	20 000 [8500–40 000]	8400 [4800–14 000]
Asia and the Pacific	5.9 million [5.1 million–7.1 million]	310 000 [270 000–380 000]	200 000 [160 000–290 000]
Latin America	1.9 million [1.6 million–2.4 million]	100 000 [79 000–130 000]	35 000 [25 000–48 000]
Caribbean	340 000 [290 000–390 000]	16 000 [11 000–24 000]	6700 [5100–9100]
Eastern Europe and central Asia	1.7 million [1.5 million–1.9 million]	150 000 [140 000–160 000]	38 000 [28 000–48 000]
Western and central Europe and North America	2.2 million [1.9 million–2.4 million]	68 000 [58 000–77 000]	13 000 [9400–18 000]
TOTAL	37.9 million [32.7 million–44.0 million]	1.7 million [1.4 million–2.3 million]	770 000 [570 000–1.1 million]

Regional epidemics

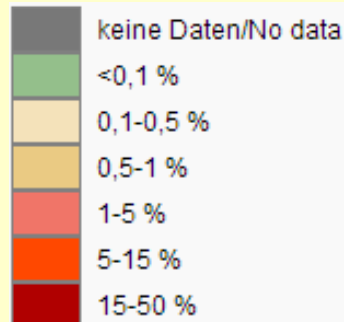
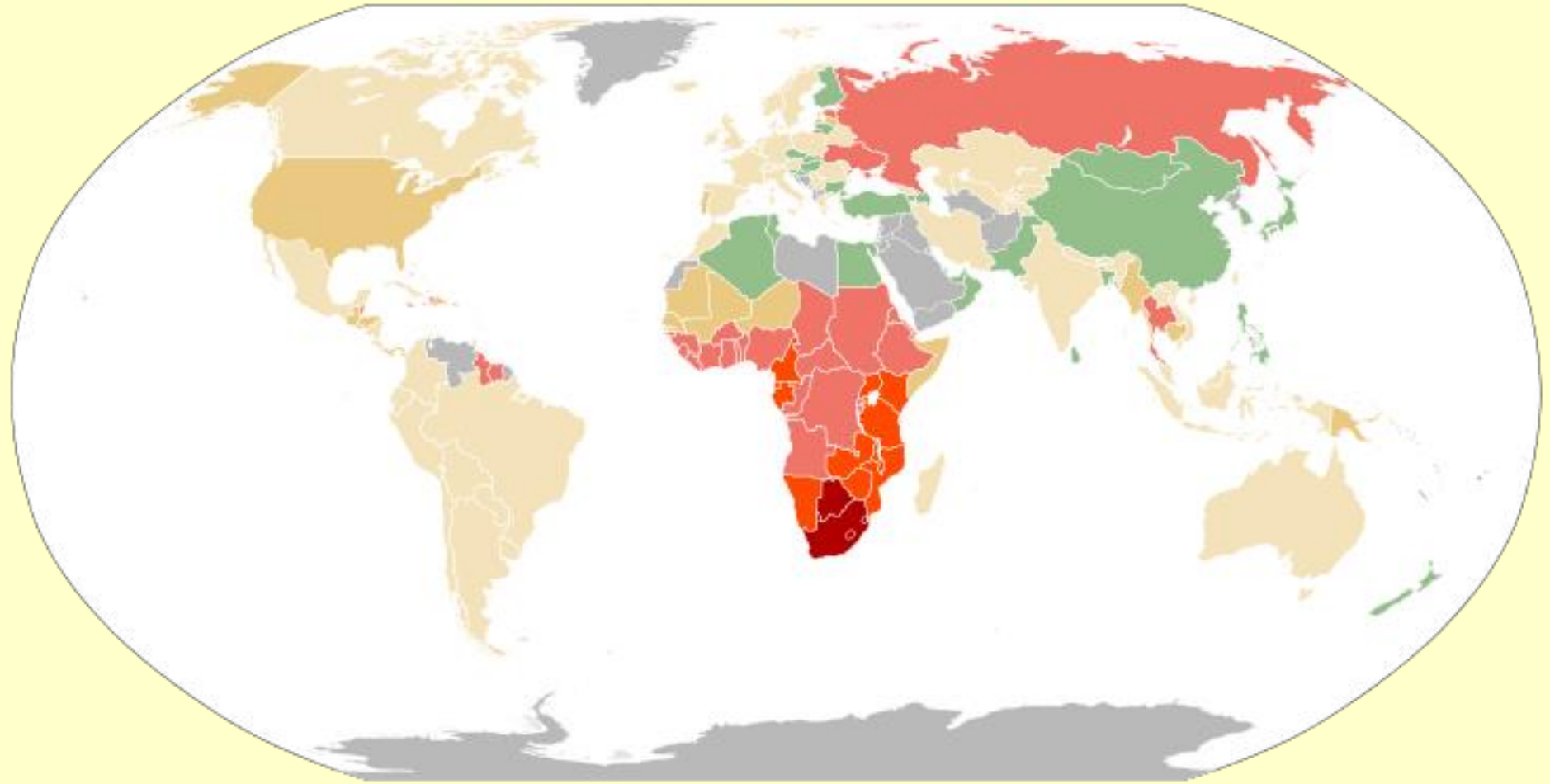

HIV

- lentivirus
- Capable of latent long-term infection
- Two subtypes : HIV-1 (common), HIV-2 (rare)

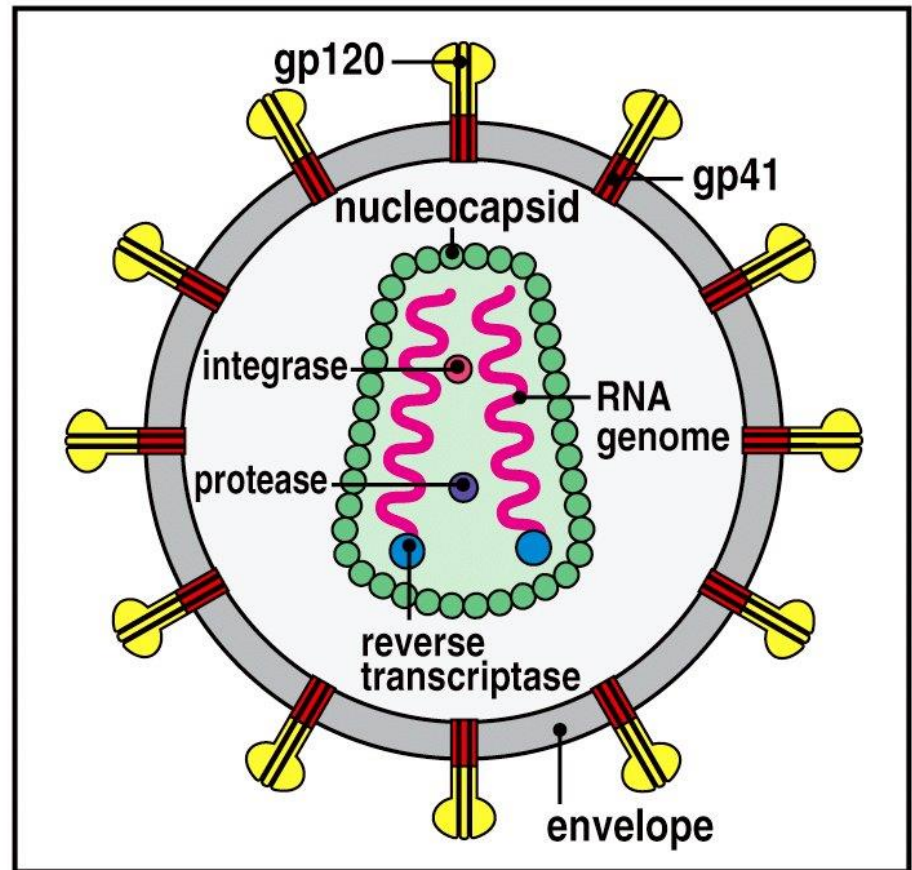
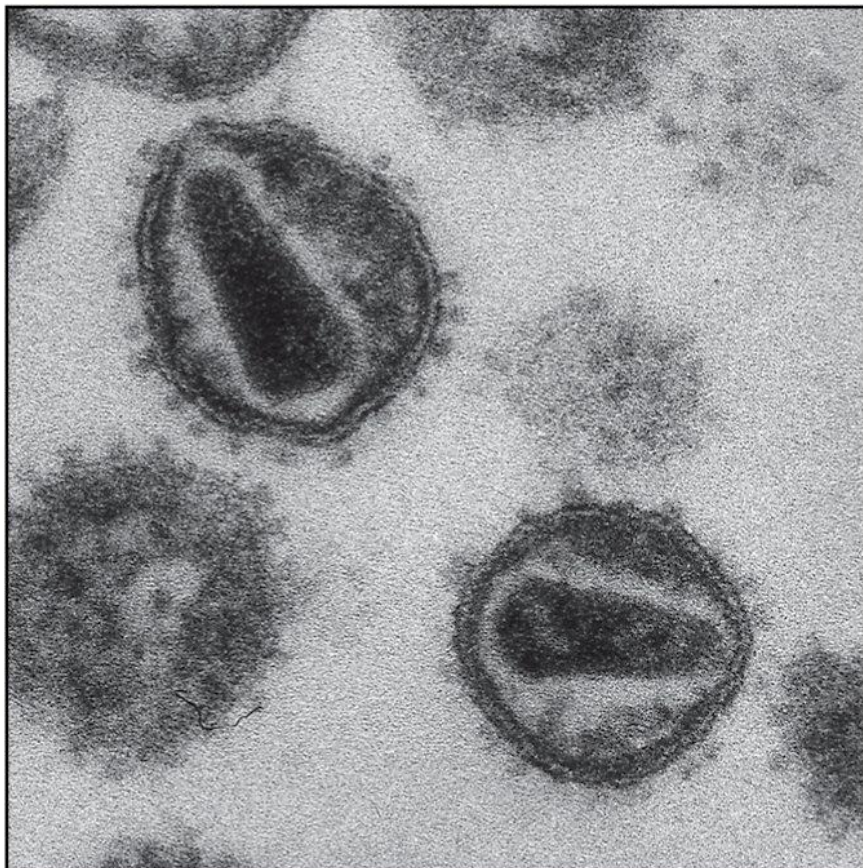
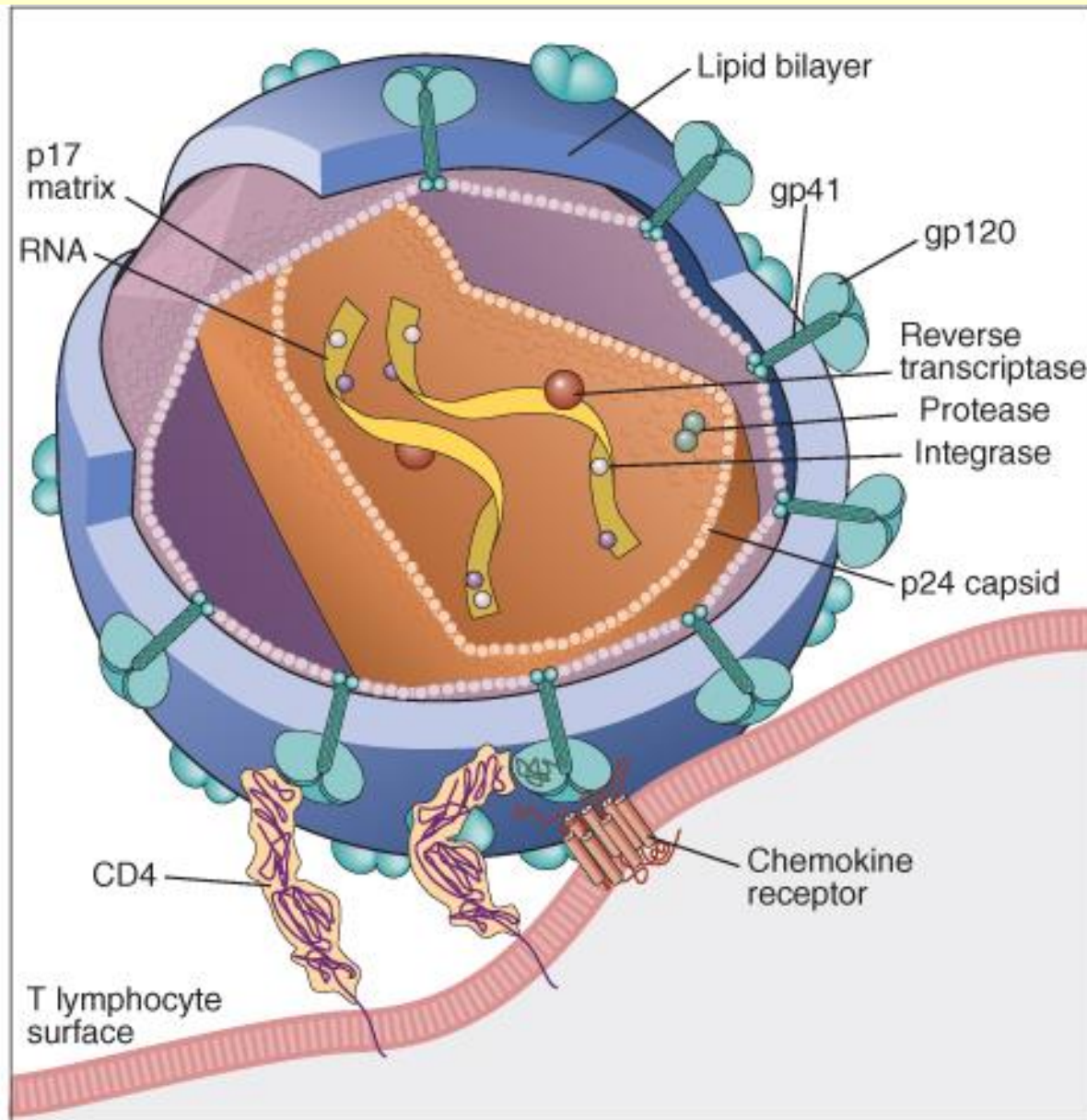

Figure 11-21 Immunobiology, 6/e. (© Garland Science 2005)

HIV



HIV receptors

- **CD4 – gp120**
- **Chemokine receptors**
 - **CXCR4 - T cell trophic virus**
 - **CCR5 – macrophage trophikus virus**
- **DC-SIGN: dendritic cell specific intercellular adhesion molecule 3 (ICAM-3) grabbing non-integrin (Binding of HIV virus to DC-SIGN does not result direct viral entry)**

The role of DC-s

HIV infection

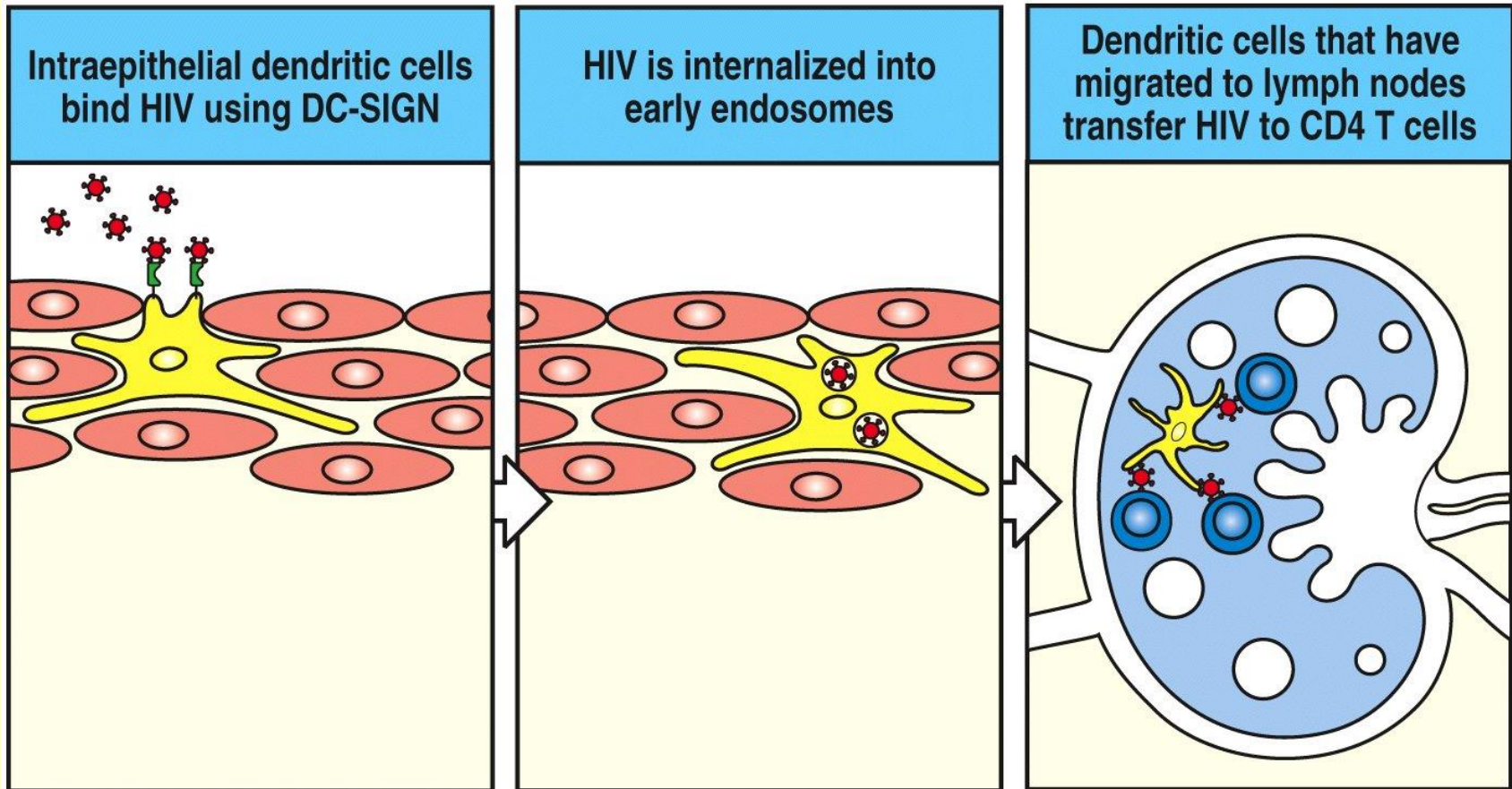
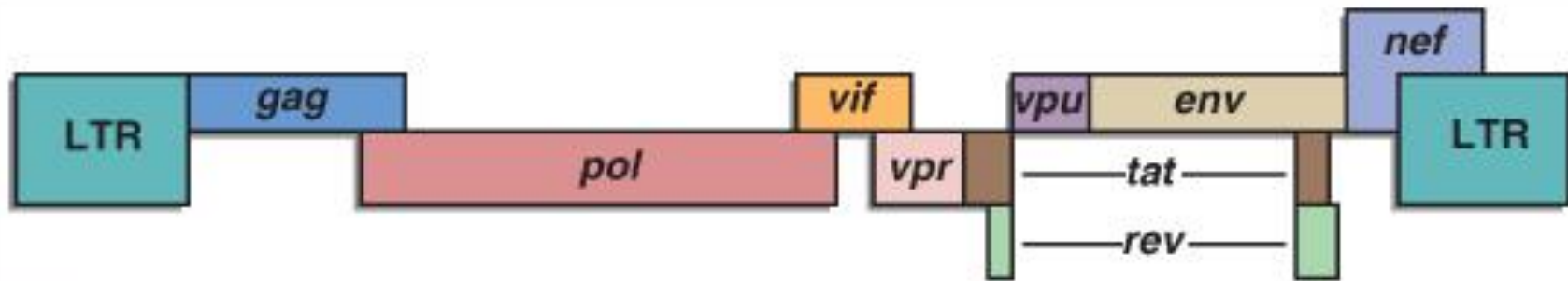

Figure 11-22 Immunobiology, 6/e. (© Garland Science 2005)

Genome of HIV



LTR	Integration of viral DNA into host cell genome; binding site for host transcription factors
gag	Nucleocapsid core and matrix proteins
pol	Reverse transcriptase, protease, integrase, and ribonuclease
env	Viral coat proteins (gp120 and gp41) mediating CD4 and chemokine receptor binding and membrane fusion
vif	Enhances infectivity of viral particles
vpr	Promotes nuclear import of viral DNA; G ₂ cell cycle arrest
tat	Required for elongation of viral transcripts
rev	Promotes nuclear export of incompletely spliced or unspliced viral RNAs
vpu	Down-regulates host cell CD4 expression and enhances release of virus from cells
nef	Down-regulates host cell CD4 expression and enhances release of virus from cells; down-regulates host cell class I MHC expression

The life cycle of HIV I.

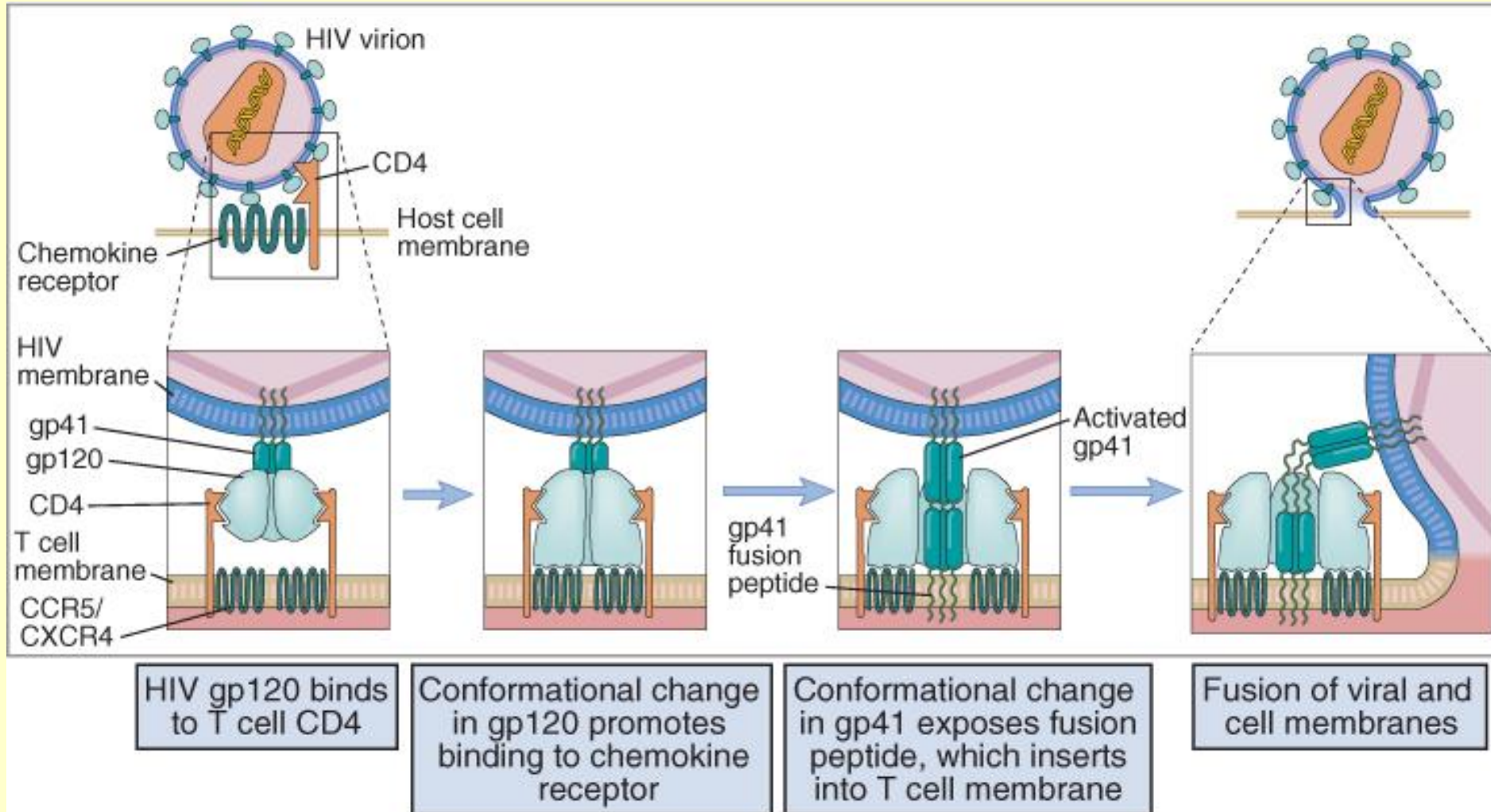

The life cycle of HIV II.

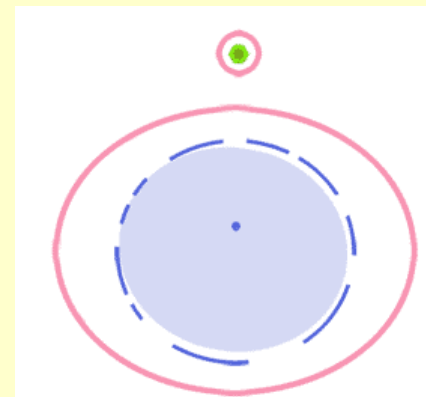
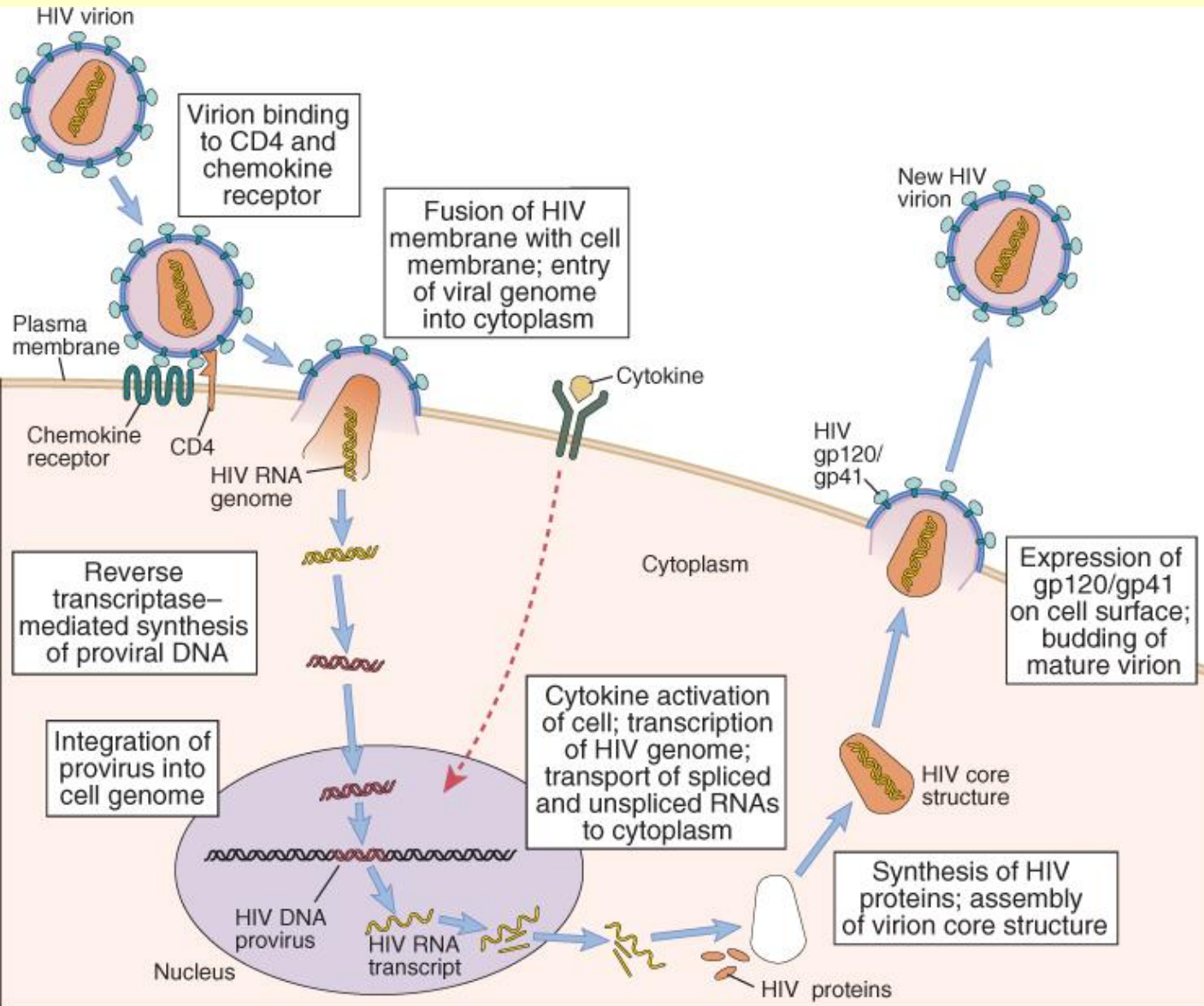
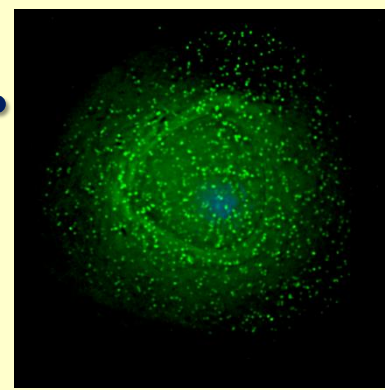

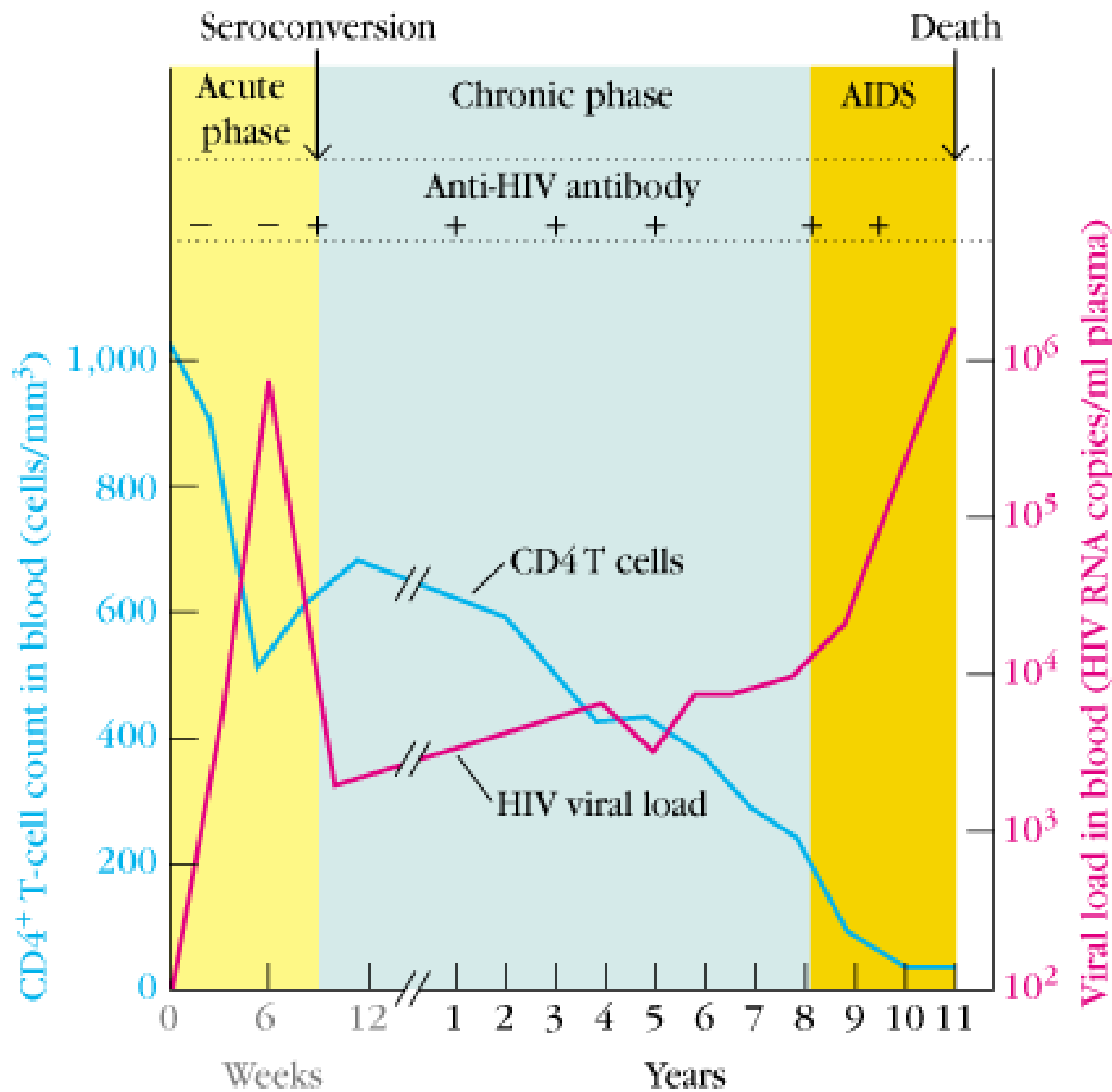

Humoral and cellular immunity against HIV

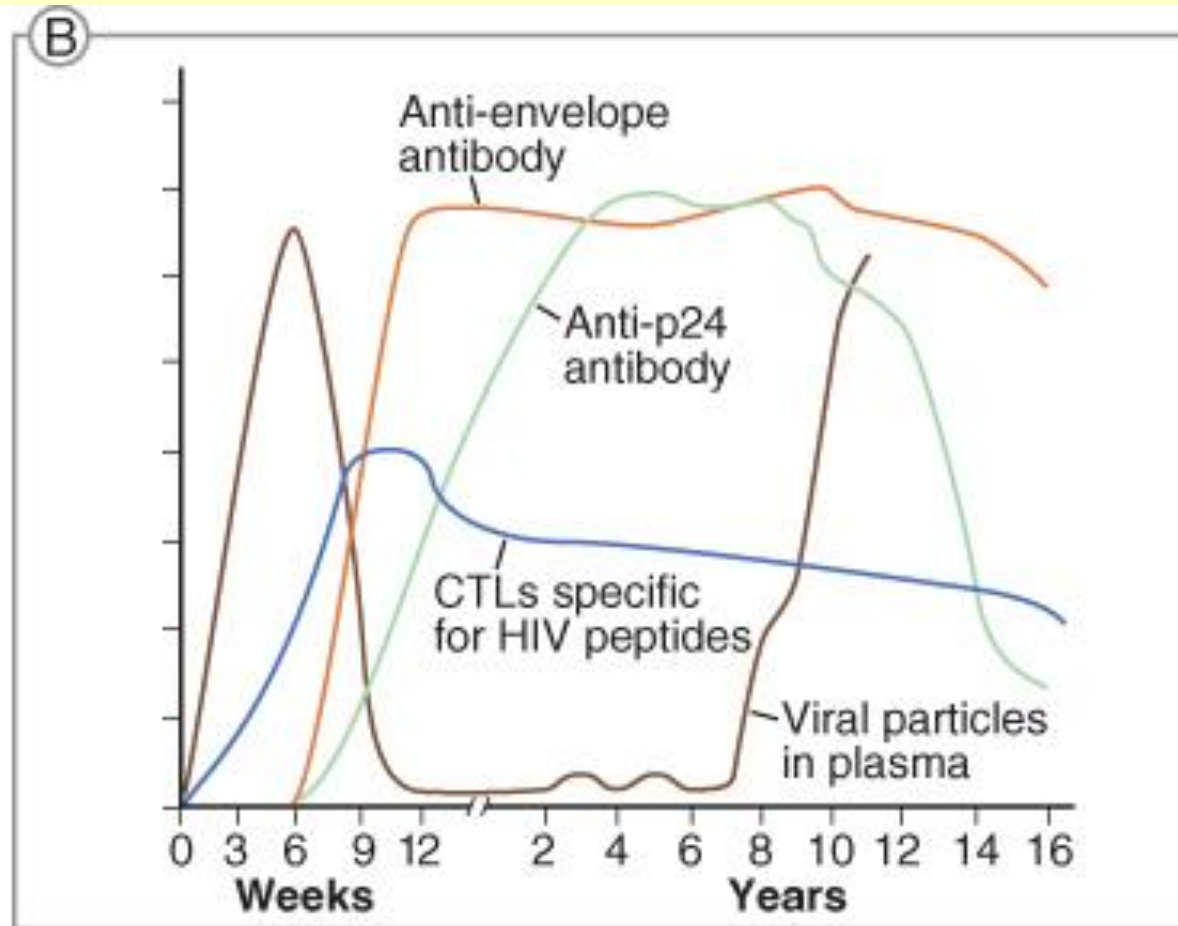

Clinical categories

CD4+ T cell numbers

A

B

C

> 500/ μ l

A1

B1

C1

200 - 499/ μ l

A2

B2

C2

< 200/ μ l

A3

B3

C3

Green categories represents AIDS syndrome

Complications in AIDS

Opportunistic infections:

- **Parasites:** Toxoplasma, Cryptosporidium, Leishmania, Microsporidium
- **Bacteria:** Mycobacteria strains, Salmonella strains
- **Viruses:** HSV, CMV, VZV

Tumors:

Kaposi-sarcoma

Non-Hodgkin-lymphoma

EBV-positive Burkitt lymphoma

Lymphoma in the CNS

Main symptoms of **AIDS**

Neurological

- Encephalitis
- Meningitis

Eyes

- Retinitis

Lungs

- Pneumocystis pneumonia
- Tuberculosis (multiple organs)
- Tumors

Skin

- Tumors

Gastrointestinal

- Esophagitis
- Chronic diarrhea
- Tumors

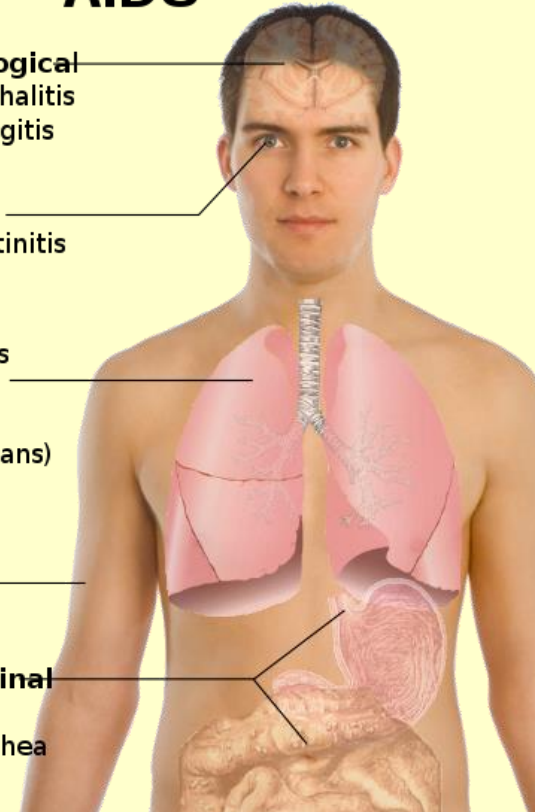

Current therapeutic approaches

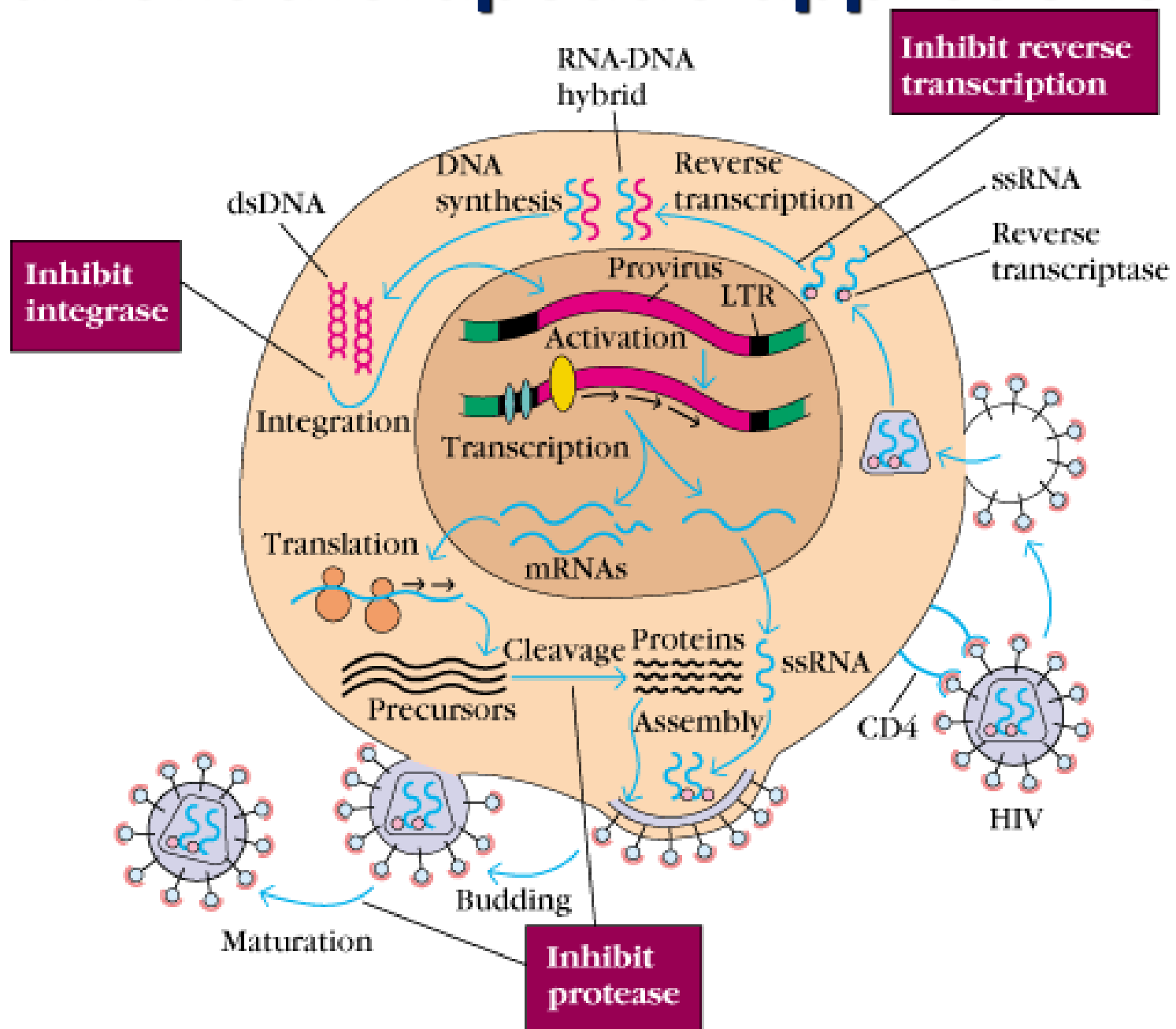
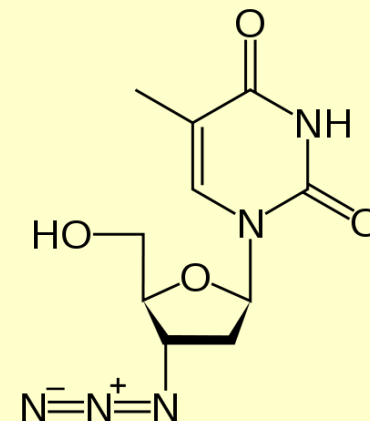
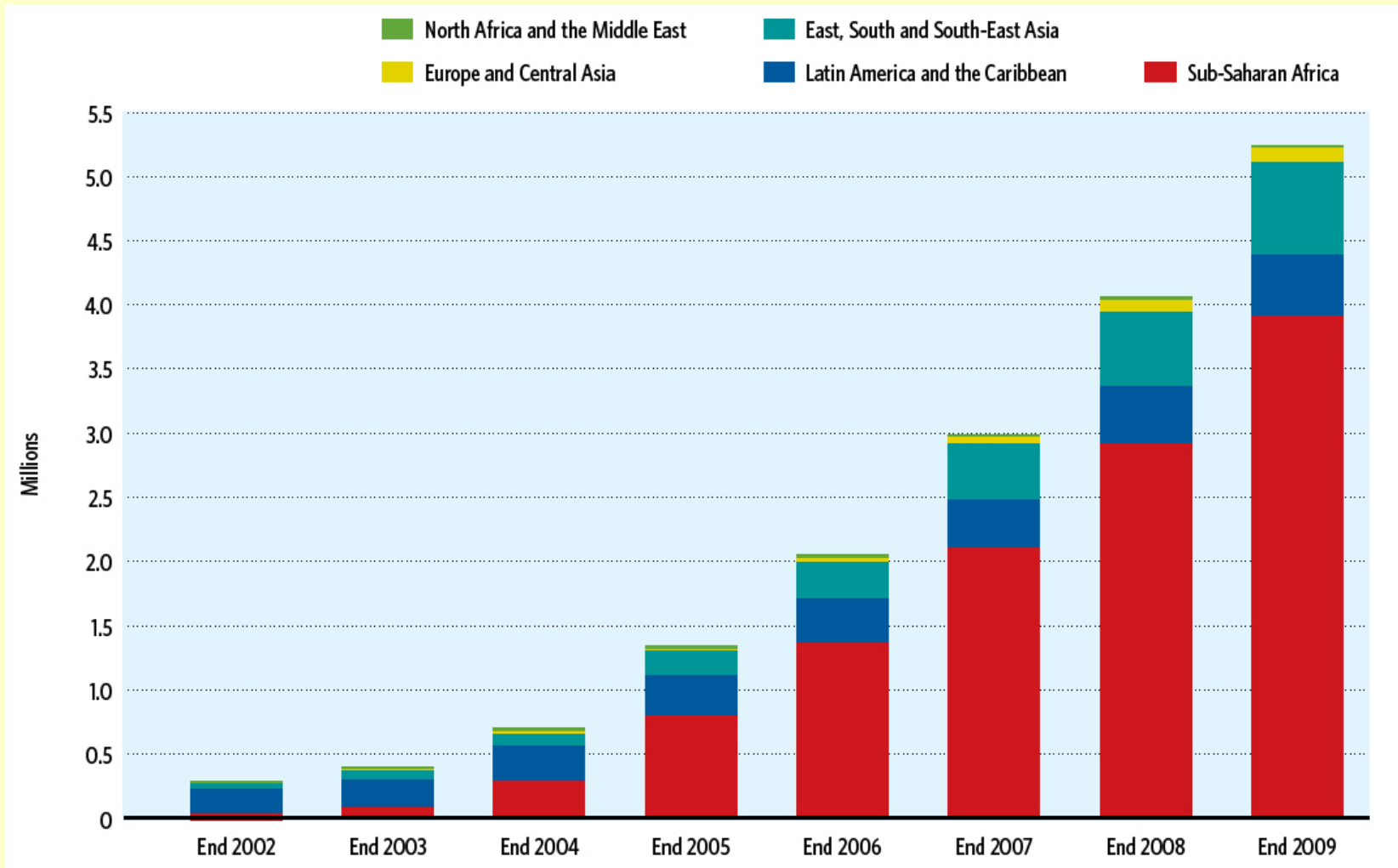

TABLE 19-5 SOME ANTI-HIV DRUGS IN CLINICAL USE

Generic name (other names)	Typical dosage	Some potential side effects
Reverse transcriptase inhibitors: Nucleoside analog		
Didanosine (Videx, ddl)	2 pills, 2 times a day on empty stomach	Nausea, diarrhea, pancreatic inflammation, peripheral neuropathy
Lamivudine (EpiViv, 3TC)	1 pill, 2 times a day	Usually none
Stavudine (Zerit, d4T)	1 pill, 2 times a day	Peripheral neuropathy
Zalcitabine (HIVID, ddC)	1 pill, 3 times a day	Peripheral neuropathy, mouth inflammation, pancreatic inflammation
Zidovudine (Retrovir, AZT)	1 pill, 2 times a day	Nausea, headache, anemia, neutropenia (reduced levels of neutrophil white blood cells), weakness, insomnia
Pill containing lamivudine and zidovudine (Combivir)	1 pill, 2 times a day	Same as for zidovudine
Reverse transcriptase inhibitors: Nonnucleoside analogues		
Delavirdine (Rescriptor)	4 pills, 3 times a day (mixed into water); not within an hour of antacids or didanosine	Rash, headache, hepatitis
Nevirapine (Viramune)	1 pill, 2 times a day	Rash, hepatitis
Protease inhibitors		
Indinavir (Crixivan)	2 pills, 3 times a day on empty stomach or with a low-fat snack and not within 2 hours of didanosine	Kidney stones, nausea, headache, blurred vision, dizziness, rash, metallic taste in mouth, abnormal distribution of fat, elevated triglyceride and cholesterol levels, glucose intolerance
Nelfinavir (Viracept)	3 pills, 3 times a day with some food	Diarrhea, abnormal distribution of fat, elevated triglyceride and cholesterol levels, glucose intolerance
Ritonavir (Norvir)	6 pills, 2 times a day (or 4 pills, 2 times a day if taken with saquinavir) with food and not within 2 hours of didanosine	Nausea, vomiting, diarrhea, abdominal pain, headache, prickling sensation in skin, hepatitis, weakness, abnormal distribution of fat, elevated triglyceride and cholesterol levels, glucose intolerance
Saquinavir (Invirase, a hard-gel capsule; Fortovase, a soft-gel capsule)	6 pills, 3 times a day (or 2 pills, 2 times a day if taken with ritonavir) with a large meal	Nausea, diarrhea, headache, abnormal distribution of fat, elevated triglyceride and cholesterol levels, glucose intolerance

**Azithiothymidin (AZT)**

Antiretroviral therapy (2002-2009)



Chemokine ligands can inhibit the binding of HIV to the target cells

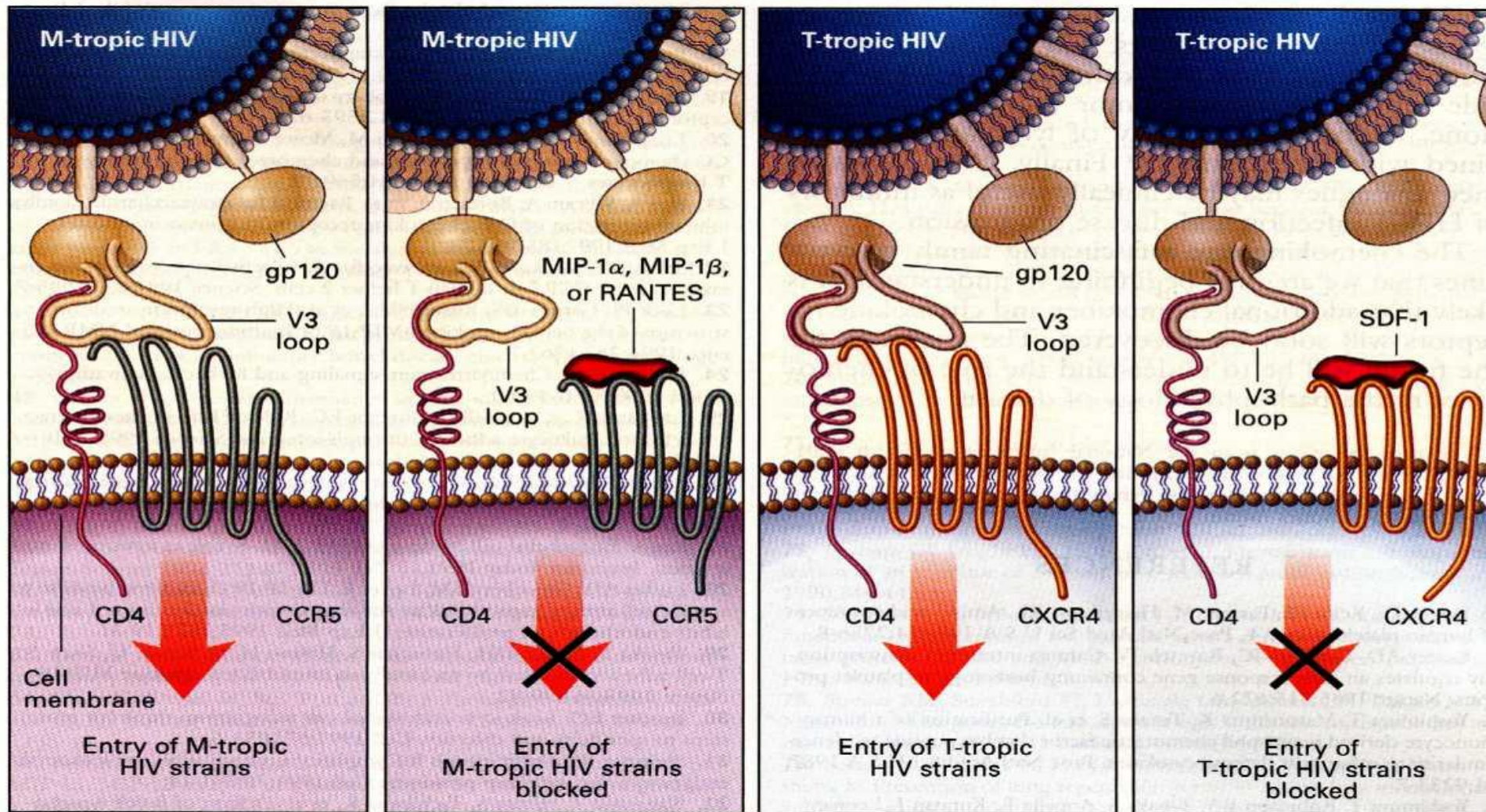



Dec. 1.

Nobel-prize 2008

HPV



Harald zur Hausen
Germany

HIV



Françoise
Barré-Sinoussi
France



Luc Montagnier
France