

Basic Immunology

Lecture 3rd and 4th

Structure, classes and functions of immunoglobulins and T cell receptors.

Recognition and presentation of antigen by MHC.

**Antigen presentation and MHC restriction.
Superantigens and toxic shock.**

Antigen recognition in adaptive immunity

Native antigens are recognized by immunoglobulins or B cell receptors.

T cells can recognize exclusively in denatured (presented) forms of the antigens.

Basic terms

immunogen (fine chemical structure can induce specific immune response)

epitope (antigen determinant) well circumscribed region of the antigen molecule targeted by Ig/BcR or TcR

hapten (small molecular weight antigen can not induce immune reaction itself, but specifically recognized by immunoglobulins)

carrier (indifferent, large molecular weight molecule, hold on the surface hapten molecules; carrier molecules did not participate in the anti-hapten immune reaction only hapten)

Immunoglobulin molecule

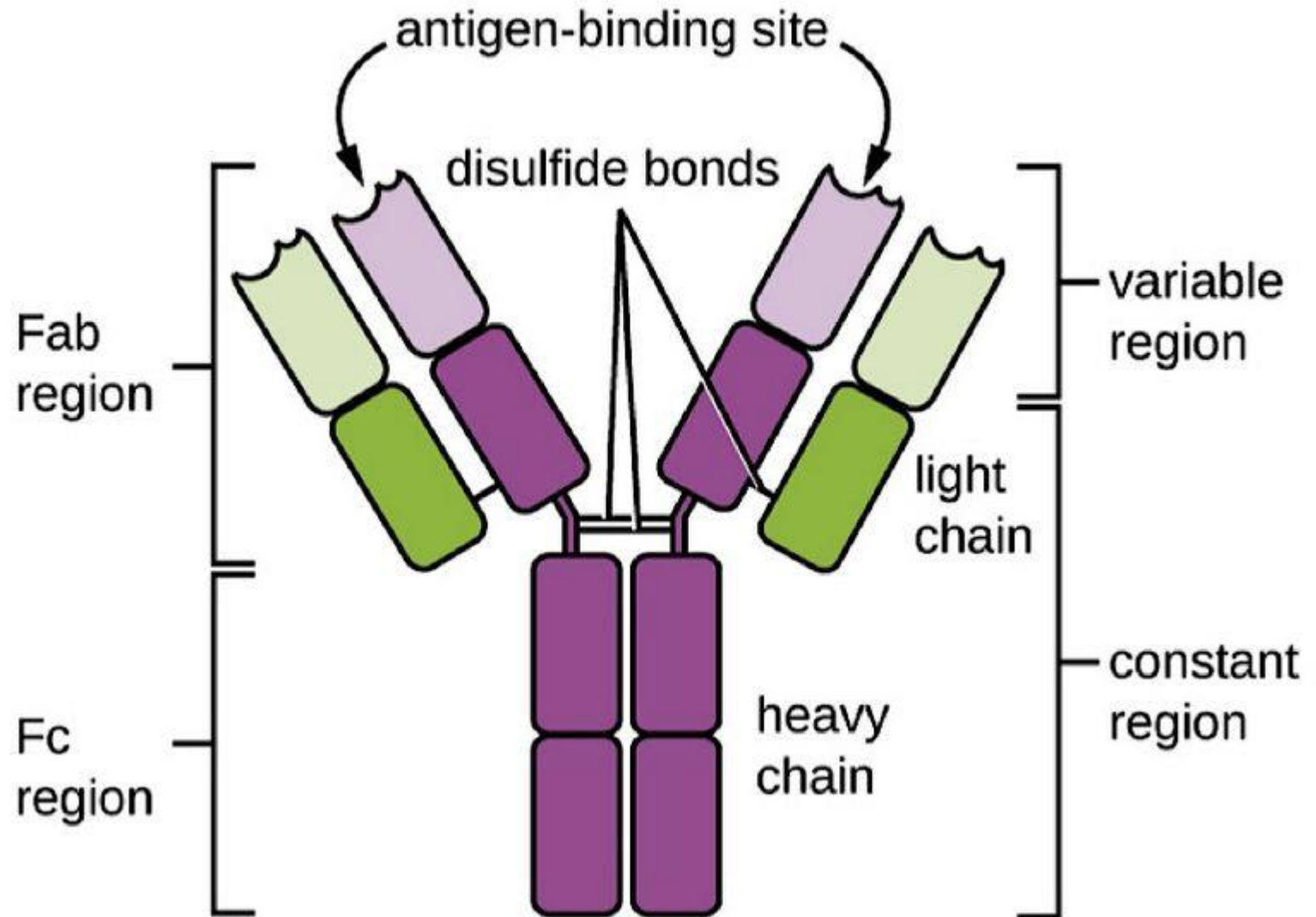

Immunoglobulin molecule

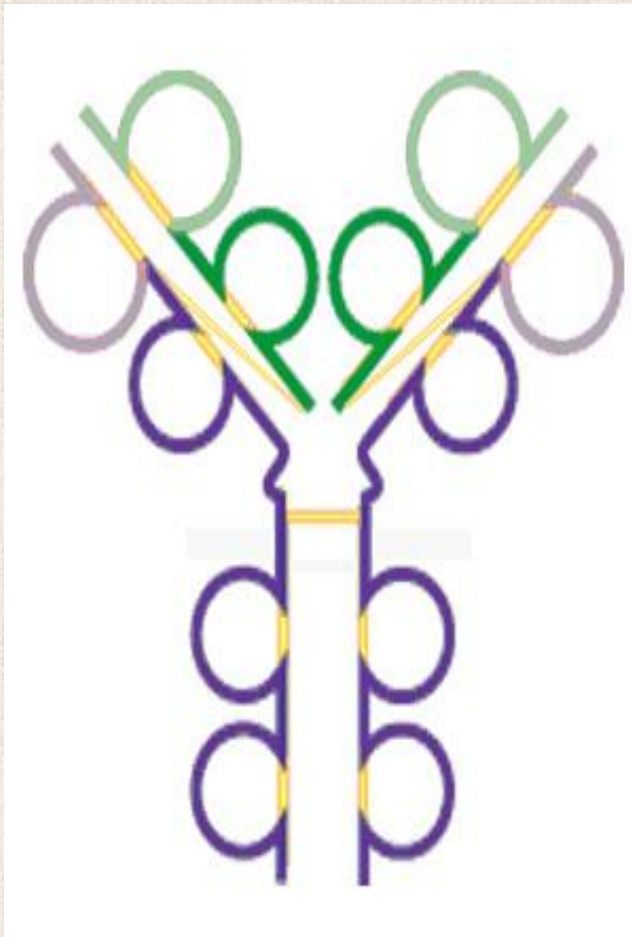

CDR
Variable region
Idiotyp
Fab fragment

Constant region
Isotype
Fc fragment

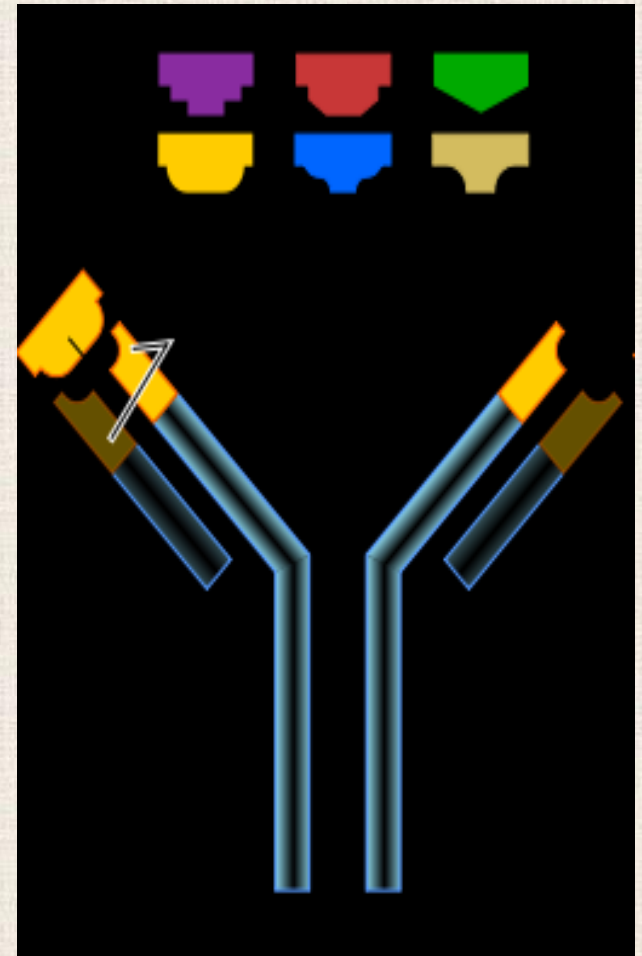

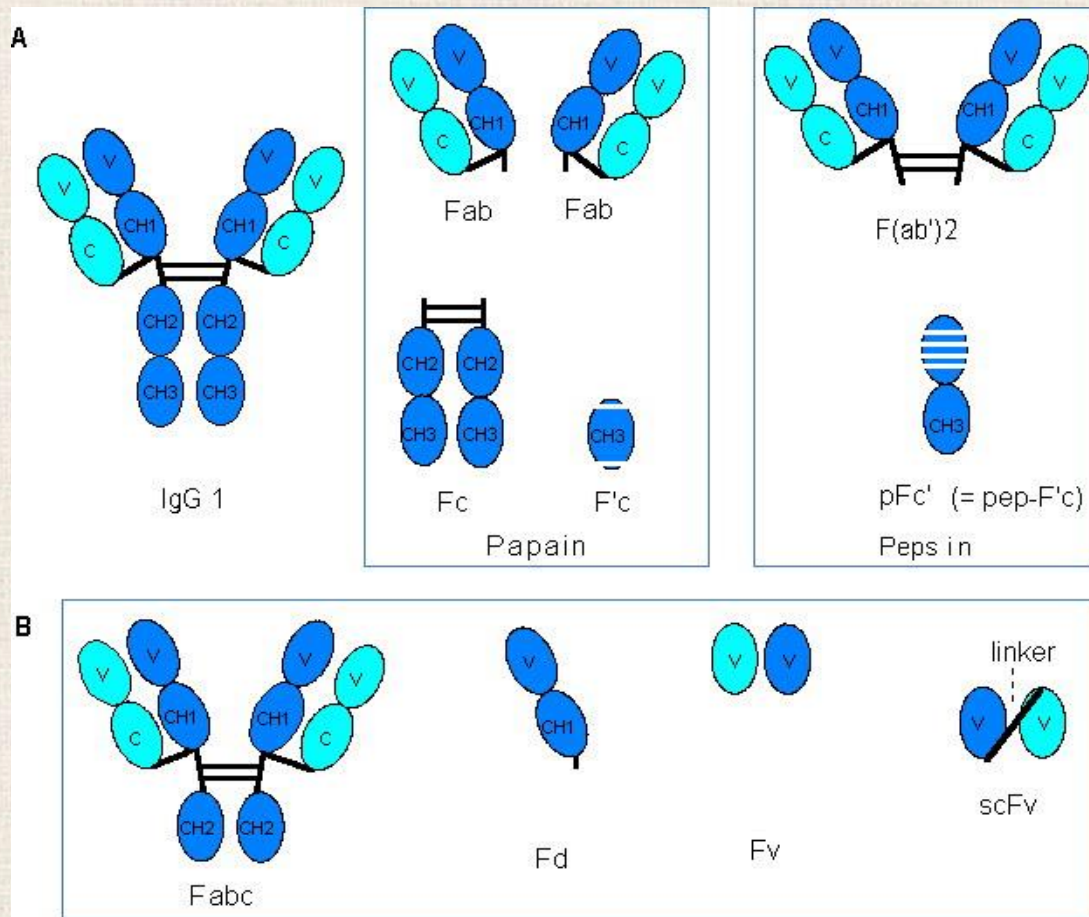

Ig domains: intra-chain disulphide bonds form loops in the peptide chain, the loops are globular, constructed from beta-plated sheets and beta-turn loops.

Immunoglobulins

Monofunctional character (specific antigen recognition and binding) ***before*** the antigen administration. **Fab** dependent function.

Polyfunctional character ***after*** the antigen administration (signal transduction, complement fixation, opsonization, immunocomplex formation, FcR binding, etc). **Fc** dependent functions.

Immunoglobulin isotypes

- Based upon the constant structures of heavy (**H**) and light (**L**) chains
- **CH isotypes:** called Ig classes and subclasses as **IgG, IgM, IgA, IgD** and **IgE**. All classes are represented in a normal serum (except the membrane bound IgD) as isotype variants.
- **CL** chain exists in two **isotypic forms:** kappa (**κ**) and lambda (**λ**), which can associate with all heavy chain isotypes.

Heavy chain	Light chain	Immuno-globulin Class	Immuno-globulin Subclass
$\gamma 1$	κ or λ	IgG	IgG1
$\gamma 2$	κ or λ		IgG2
$\gamma 3$	κ or λ		IgG3
$\gamma 4$	κ or λ		IgG4
$\alpha 1$	κ or λ	IgA	IgA1
$\alpha 2$	κ or λ		IgA2
μ	κ or λ	IgM	
δ	κ or λ	IgD	
ϵ	κ or λ	IgE	

Pronunciation of Greek letters:

γ gamma α alpha μ mu δ delta
 ϵ epsilon κ kappa λ lambda

Structure of Immunoglobulin G1

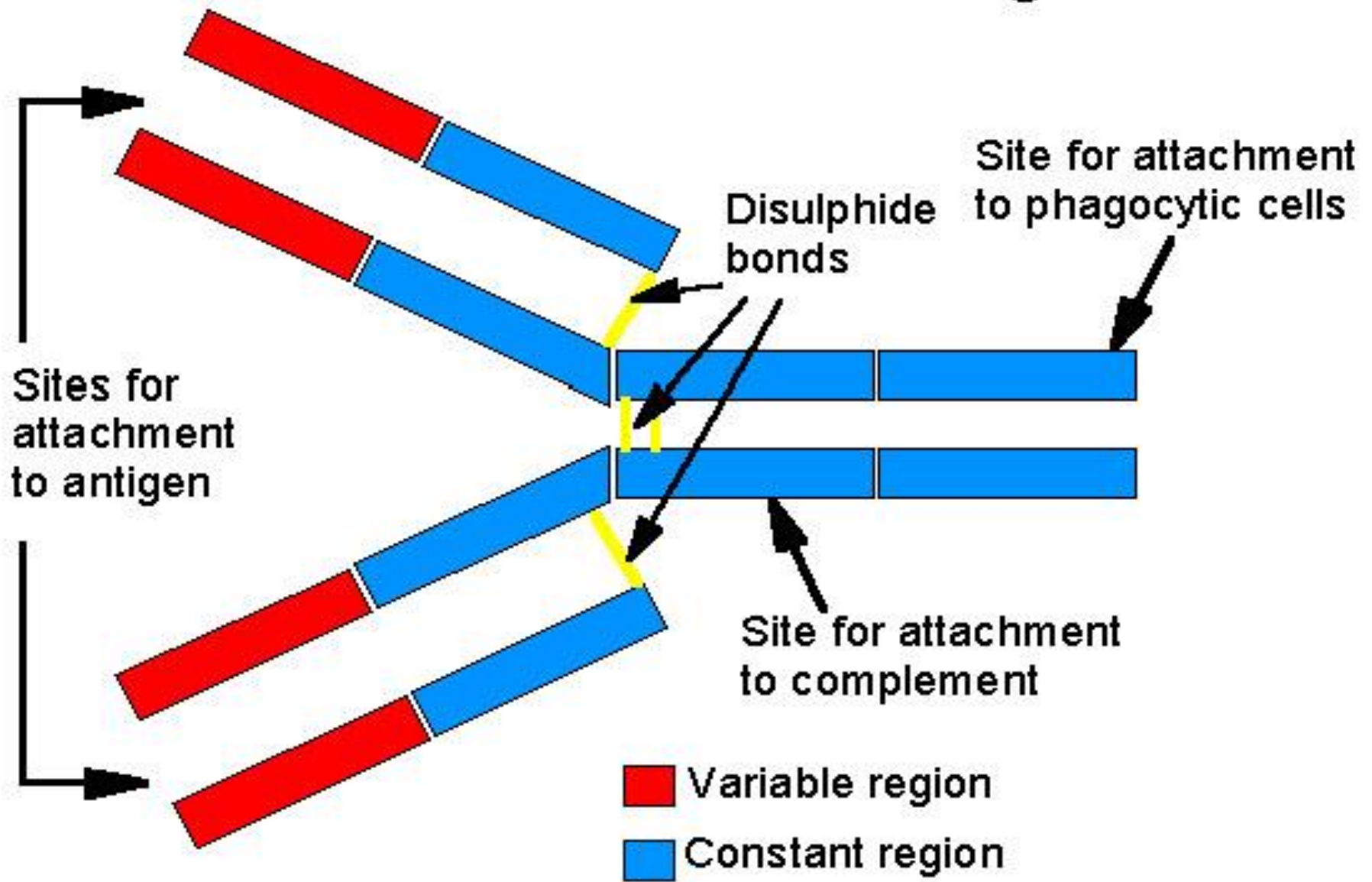

IgA and IgM

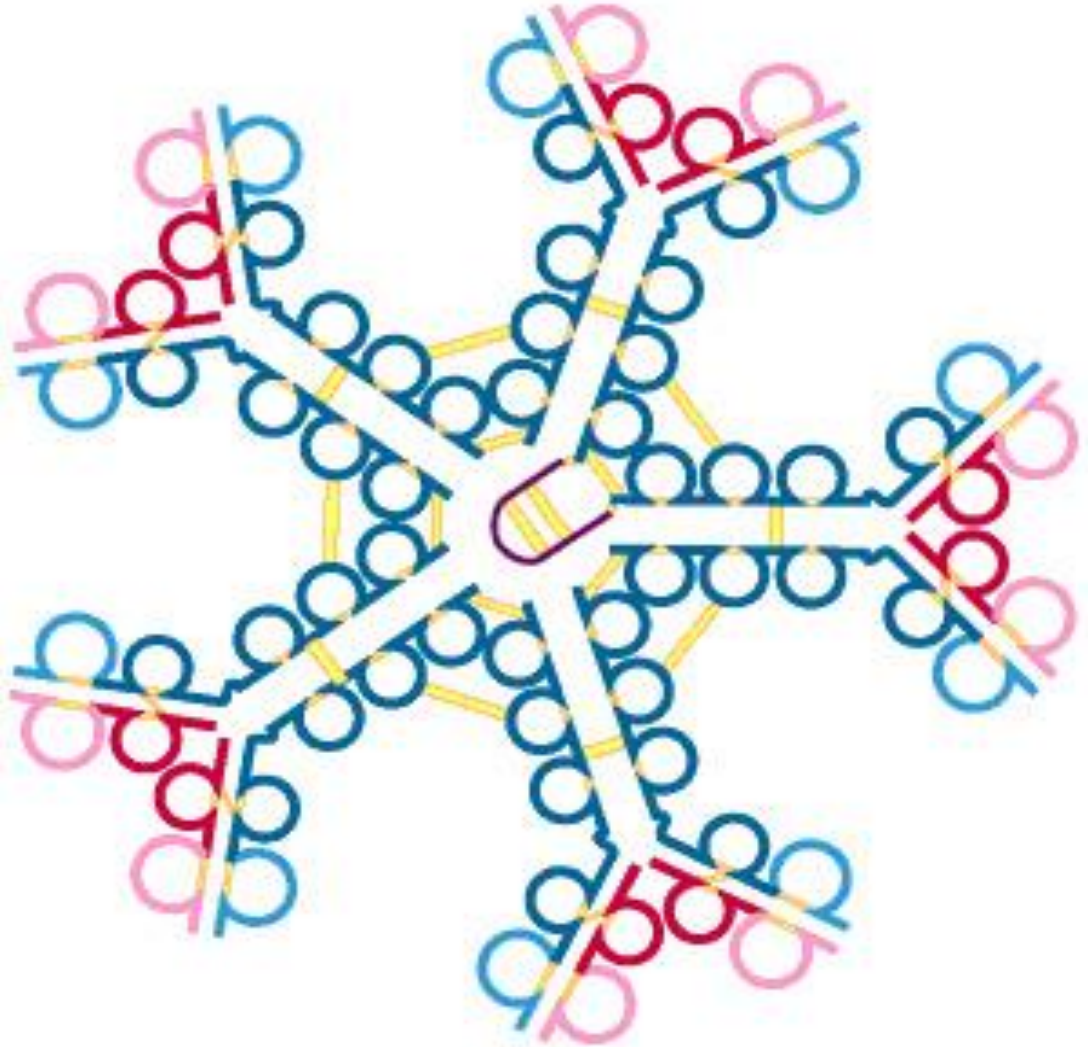

Immunoglobulin E

with name of each domain

Sites for attachment to antigen

Sites for attachment to mast cells and basophils

Carbohydrate

 Variable regions

 Constant regions

 Disulphide bonds

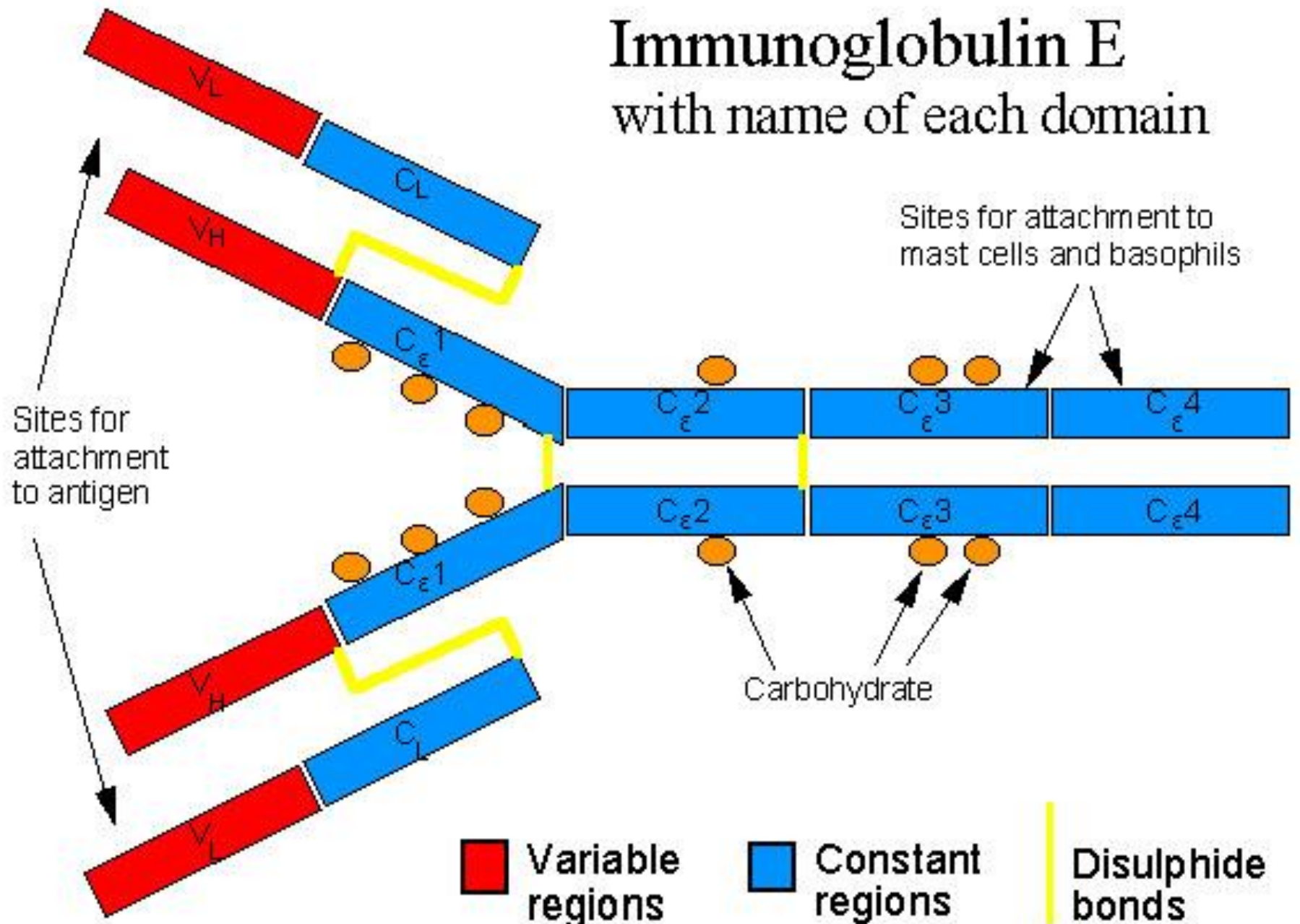

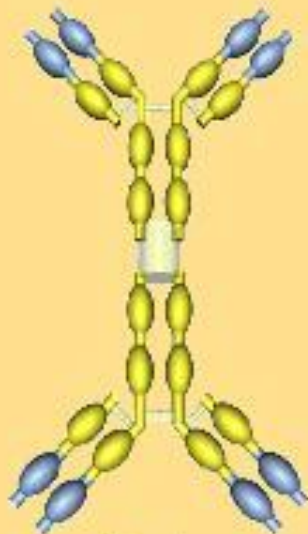

IgA

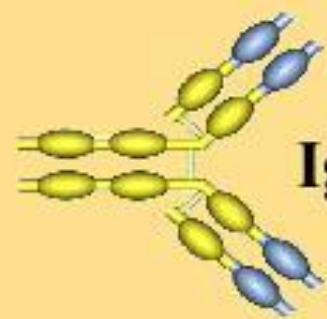

IgD

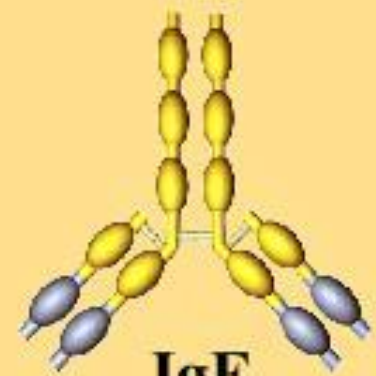

IgE

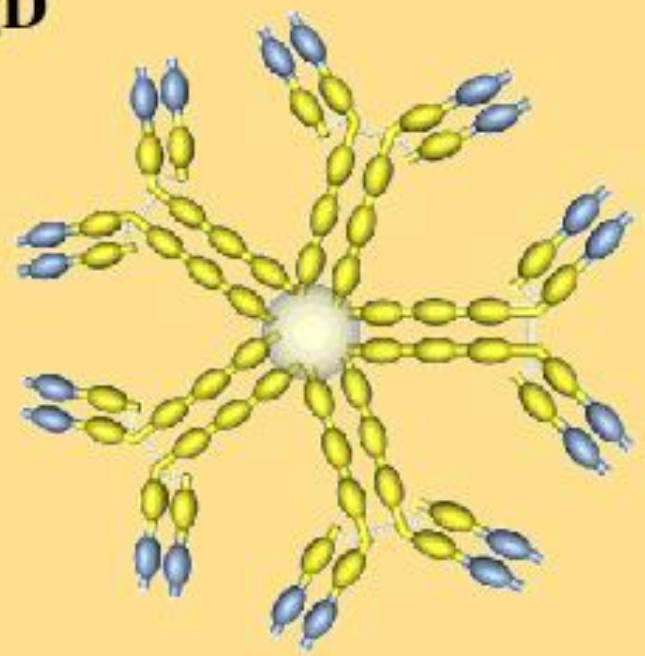

IgM

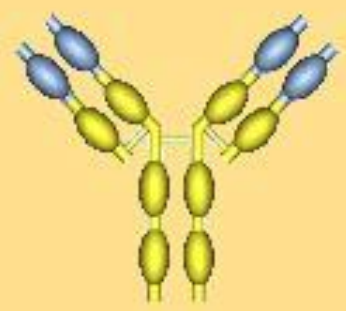

IgG

Immunoglobulin idiotypic

Individual determinants in **V regions**, specific for each antibody.

The N terminal Ig domain contains V region forming the antigen binding site: clustering the 3 hyper variable sequences close to each other on both chains - the variation of 3 x 3 results tremendous diversity.

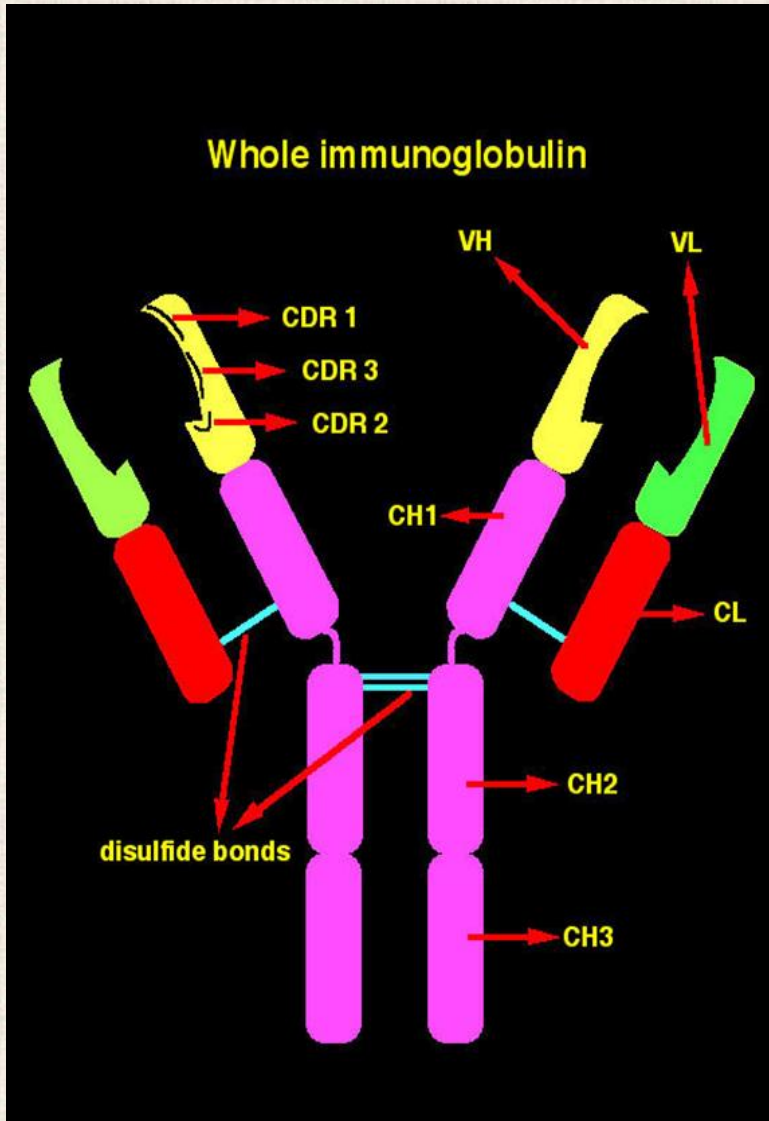

Construction of idiotype by immunoglobulin rearrangement

Génátrendeződés



1 2 3 Szomatikus hipermutációk

Gene rearrangement



1 2 3

Somatic hypermutations

Hírvivő RNS

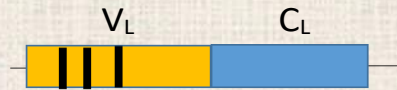

CDR

1 2 3

Messenger RNA

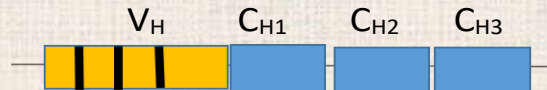

1 2 3

Immunglobulin fehérje

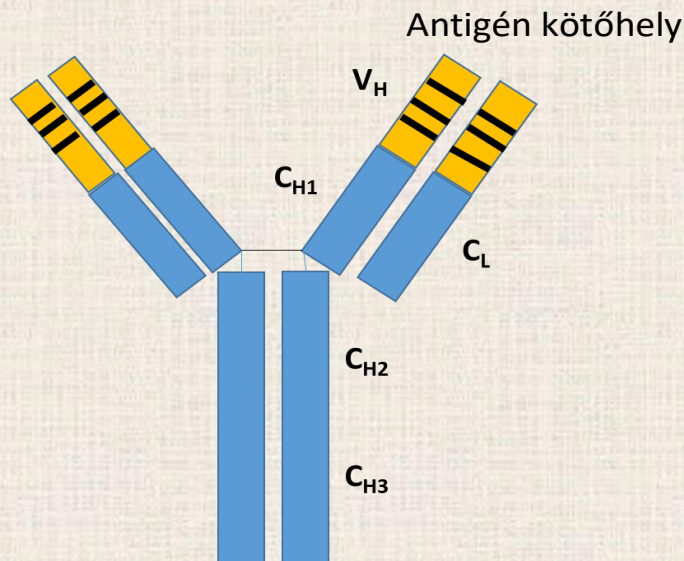

Antigén kötőhely

Immunglobulin protein

Antigen binding site

Human immunoglobulins

IgG – blood, lymph, make up 80% of Ig only Ig of maternal origin to pass the placenta wall give newborns (Mw 150 kD) neutralize toxins and viruses

IgM – Blood, lymph (cell surface) pentamer structure (Mw 900 kD) first antibodies formed in response to initial infection.

IgA – Mucosal surfaces, blood (active in dimeric or tetrameric form) (Mw 150-600 kD)

IgD – only membrane-bounded form in B-cell surfaces (Mw 150 kD) may function in initiation of antibody-antigen response

IgE – blood, in periphery can bound to basophiles and mast cells (Mw 190 kD) plays role in defence against parasites and initiation of allergic reactions

Antigen – antibody reactions

- **Neutralization (e.g. viruses, toxins)**
- **Precipitation (soluble molecules)**
- **Agglutination (particles, cells)**
- **Opsonization (large particles)**
- **Complement fixation**

B cell Receptor (BcR) Complex

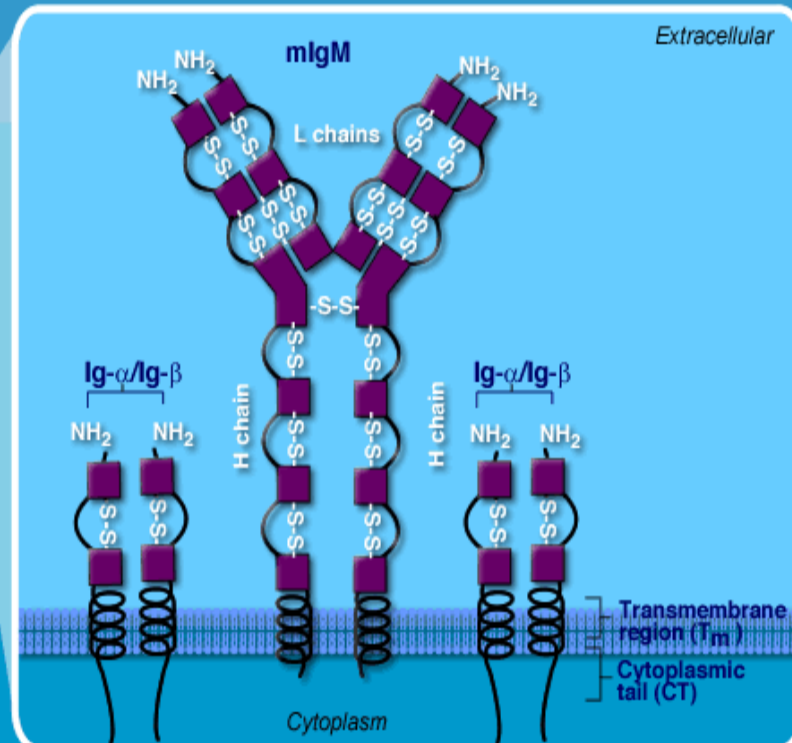
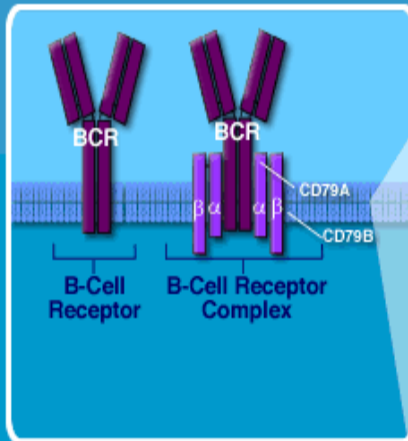
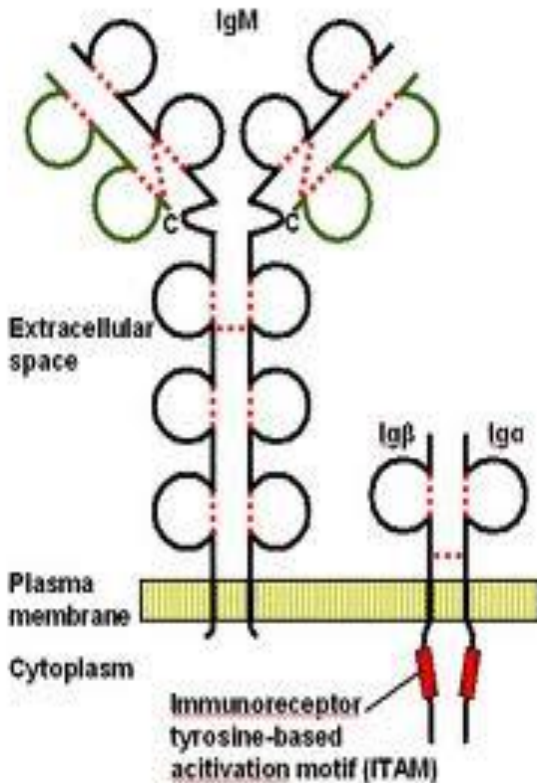

T Cell receptor

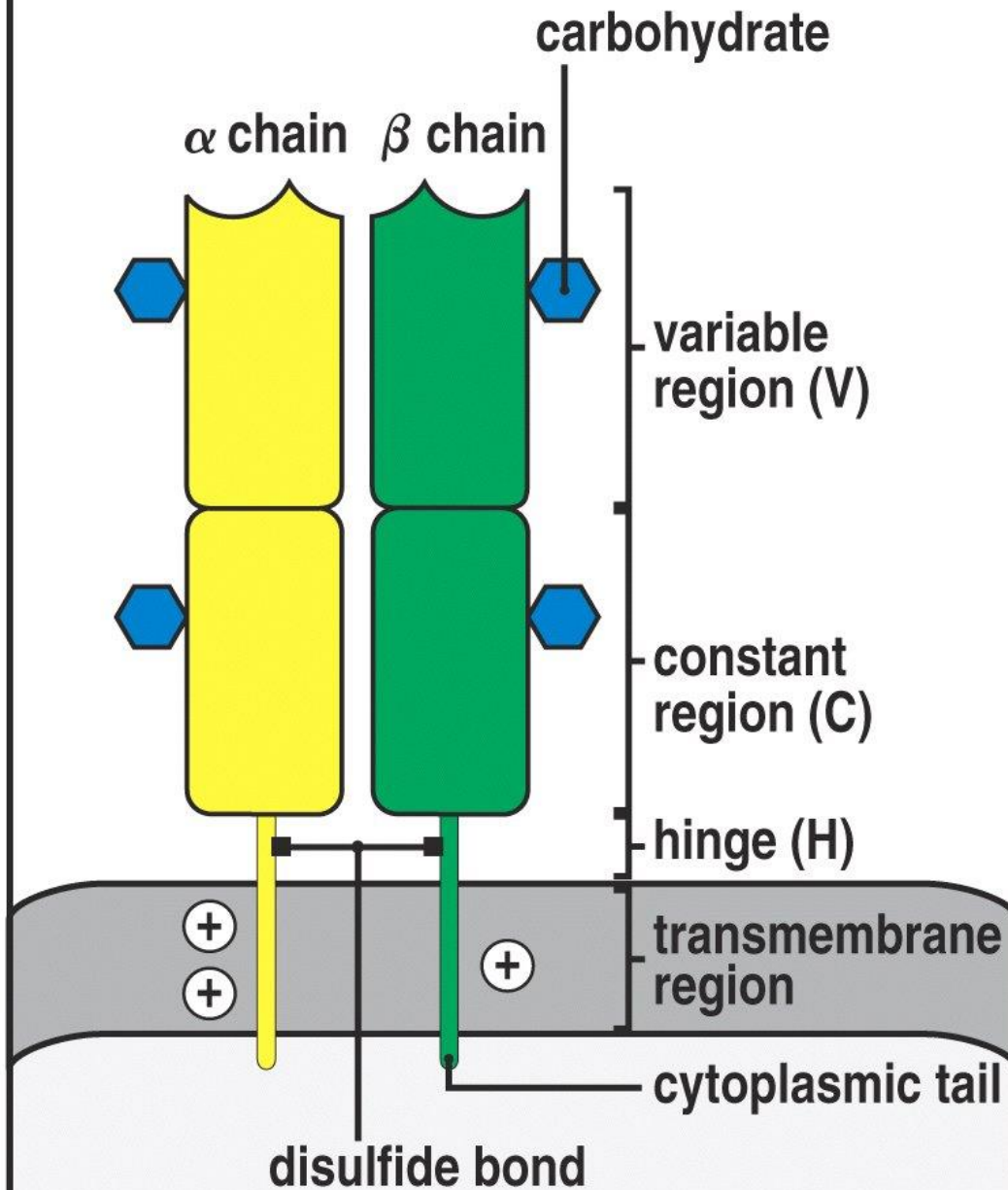
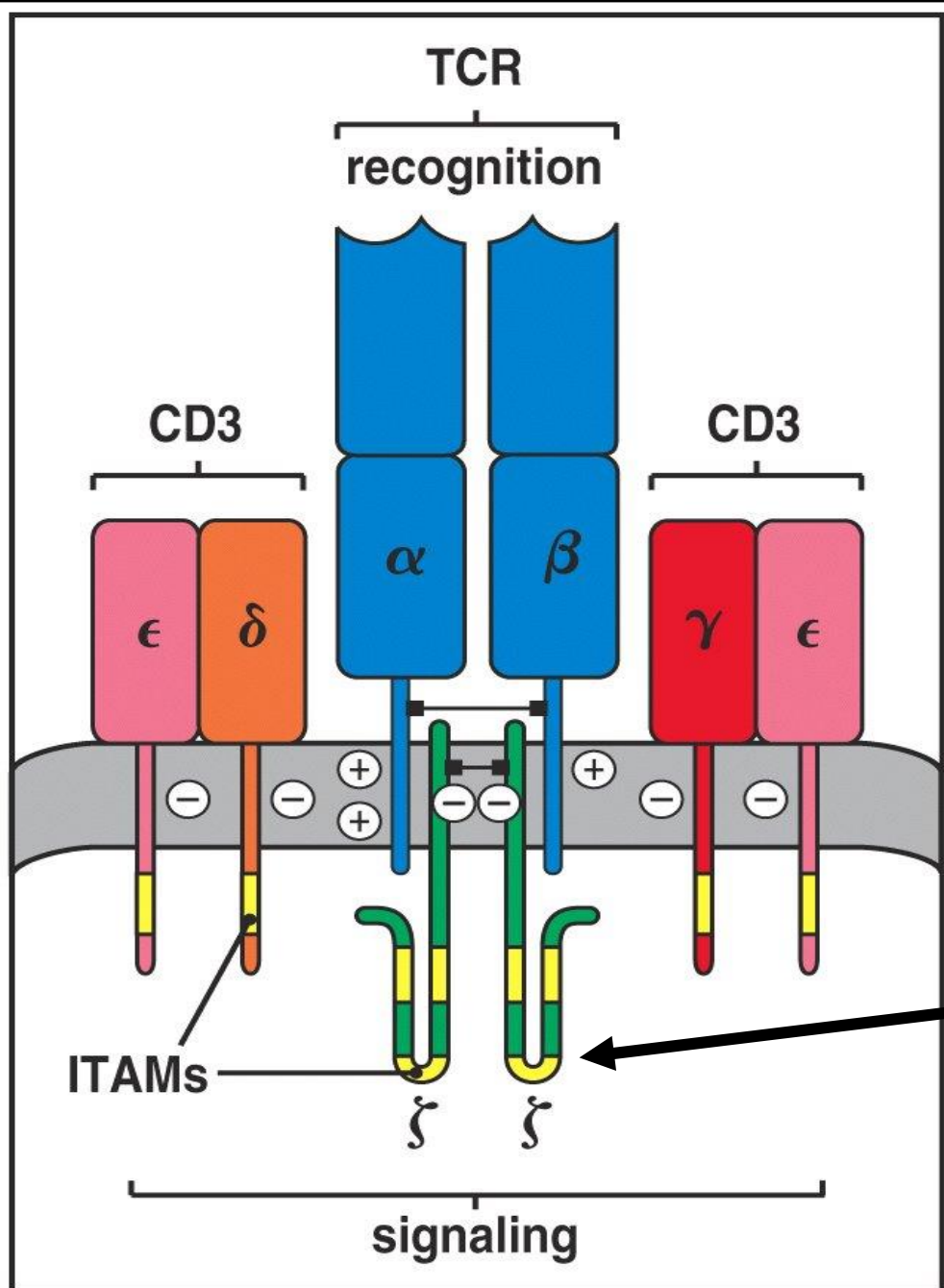

Figure 3-12 Immunobiology, 6/e. (© Garland Science 2005)

T Cell Receptor complex



ITAMs
Immunoreceptor
Tyrosine-based
Activation
Motifs

Antigen Recognition by T Cells

-T cells recognize antigens only displayed on surfaces of the body's own cells as MHC and peptide complexes

Main T cell types:

-CD8+ (cytotoxic) T-cells

MHC Class I - peptide complex

-CD4+ (helper) T-cells

MHC Class II - peptide complex

Major Histocompatibility Complex

Self and foreign antigens are presented on the cell surface by specialized host-cell glycoproteins encoded in a large cluster of genes that were first identified by their effects on the immune response to transplanted tissues. For that reason, the gene complex was termed the **M**ajor **H**istocompatibility **C**omplex (MHC). The antigen binding glycoproteins are called MHC molecules/antigens. (MHC vs. HLA, H2, BoLA, ChLA etc.)

Inbred strains of mice



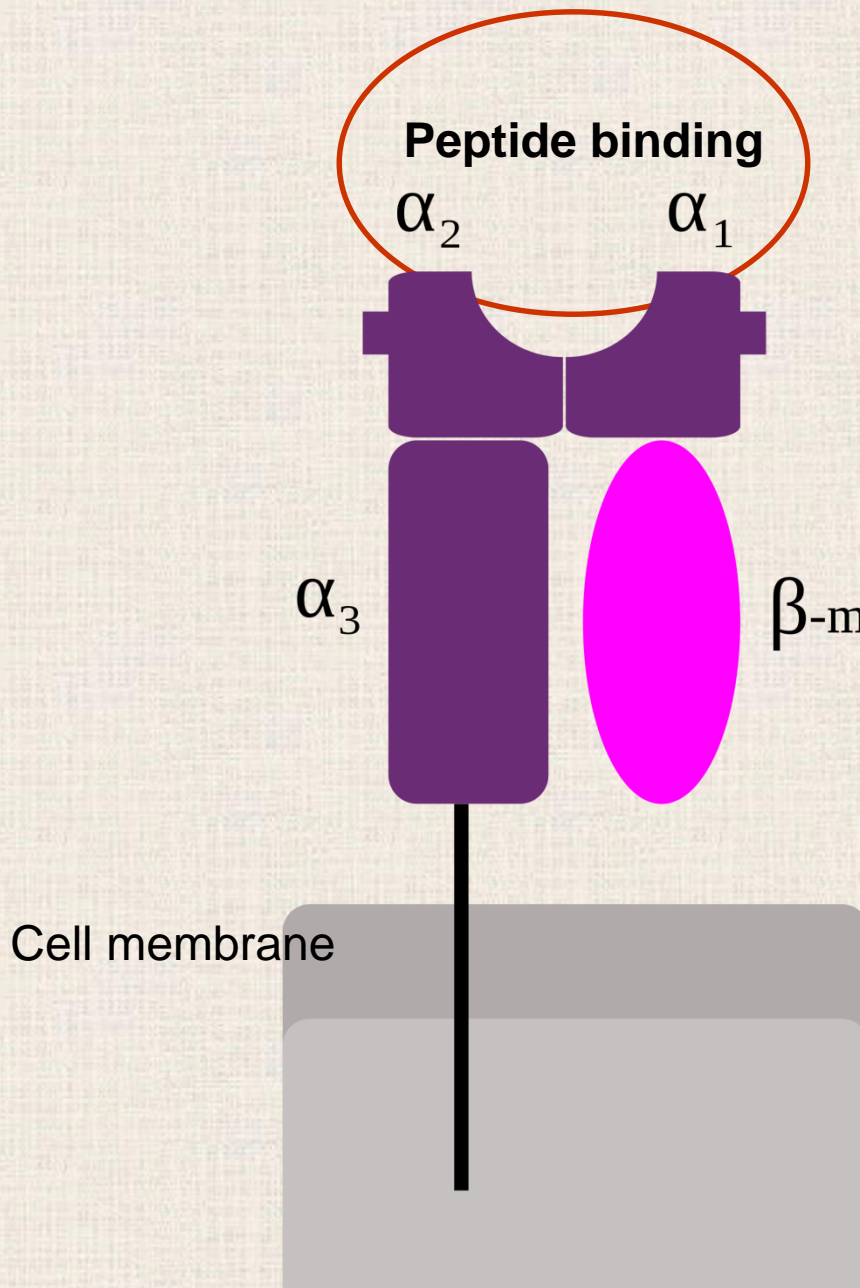

MHC Class I

Present in all nucleated cells and platelets

Antigen binding site of MHC class I

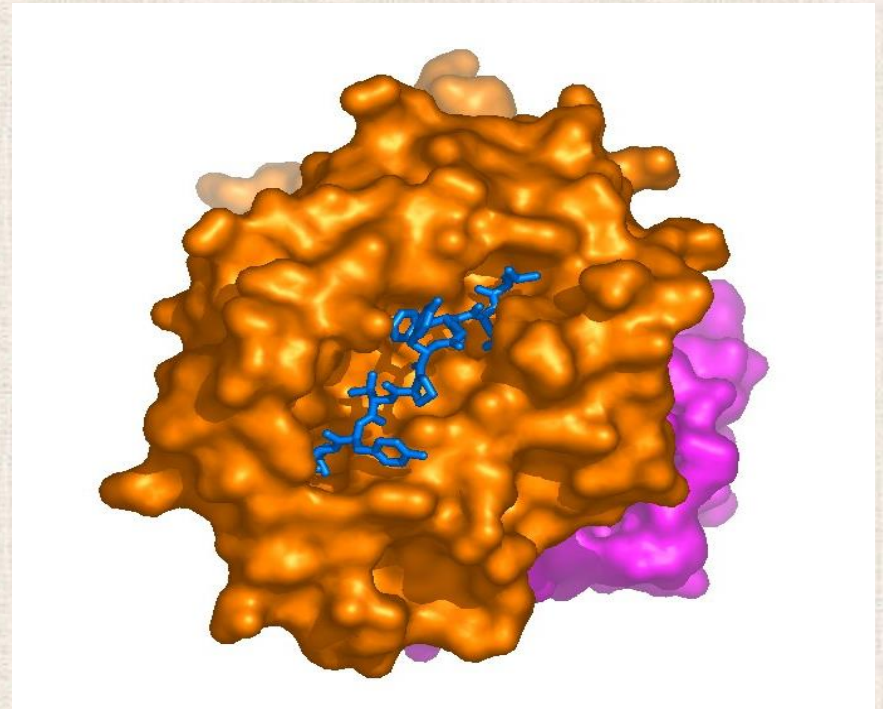
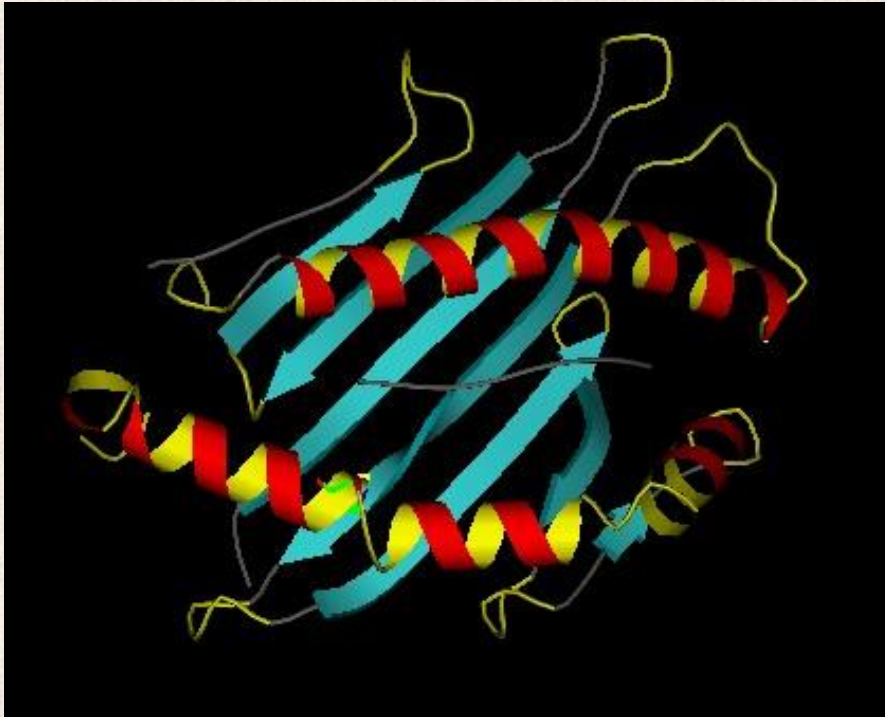

MHC Class II

Present in professional or facultative antigen presenting cells (APC)

Professional antigen presenting cells: dendritic cells, monocytes, macrophages, B cells, thymus epithelial cells

Facultative antigen presenting cells: inflammatory epithel and endothel in pathologic conditions

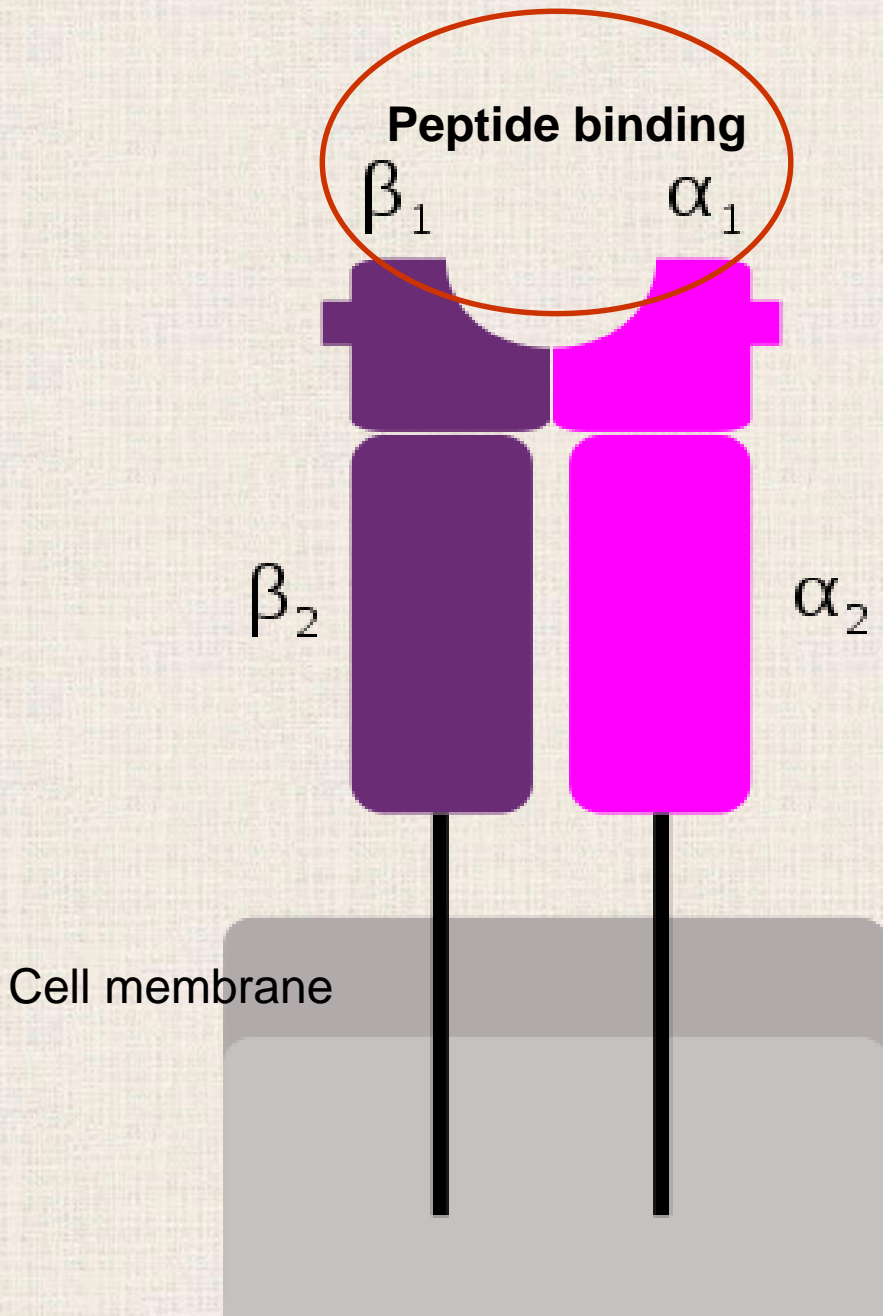

Antigen binding site of MHC class II

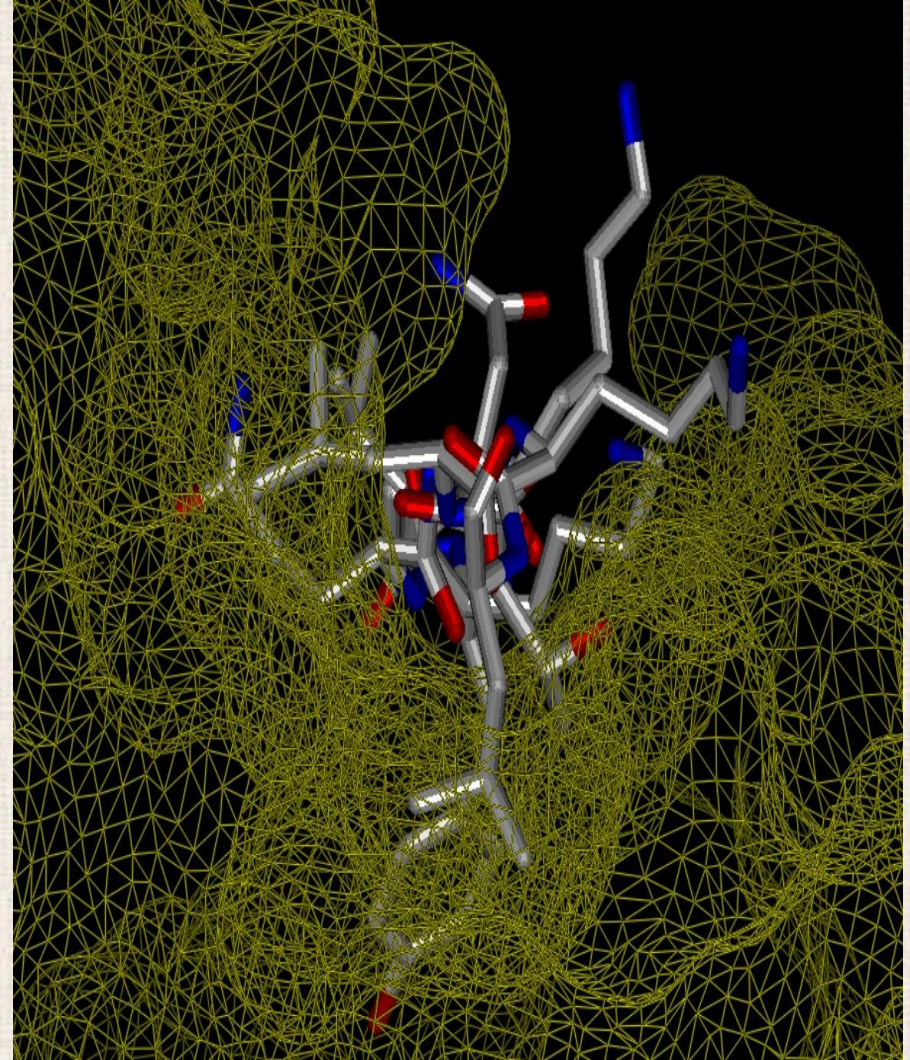
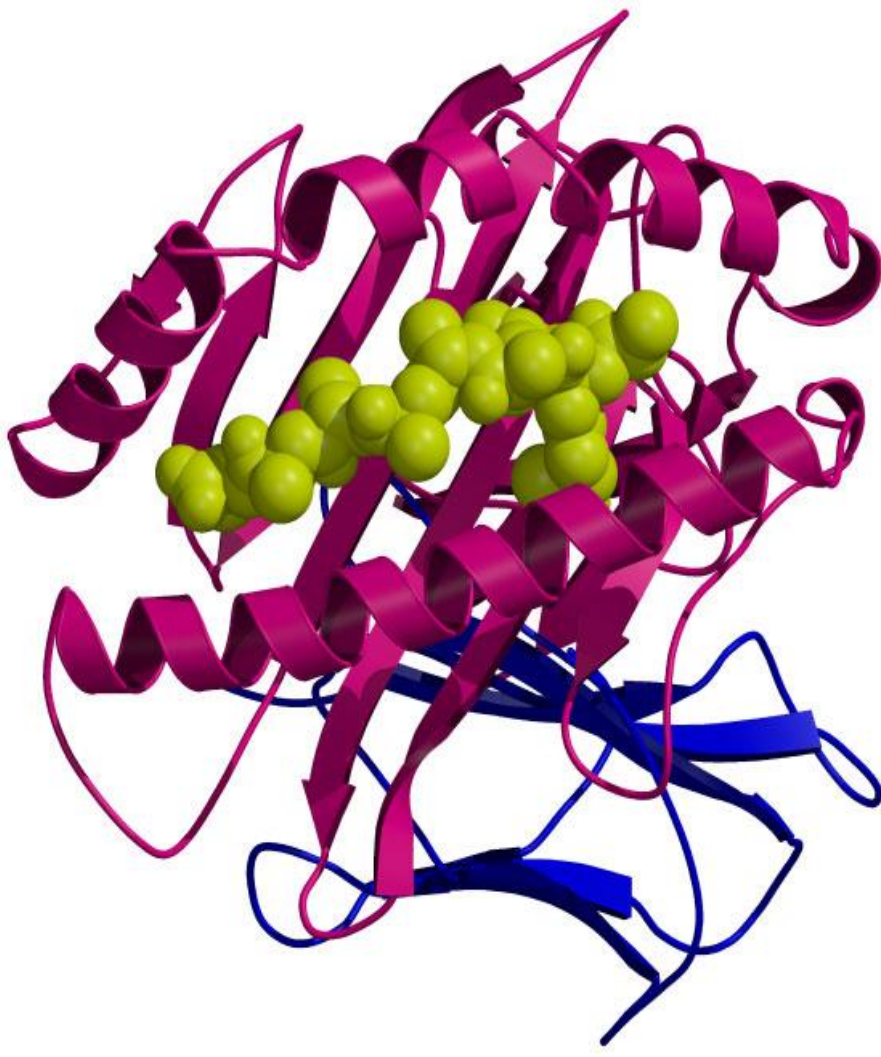

Structure of MHC genes

MOUSE CHROMOSOME 17

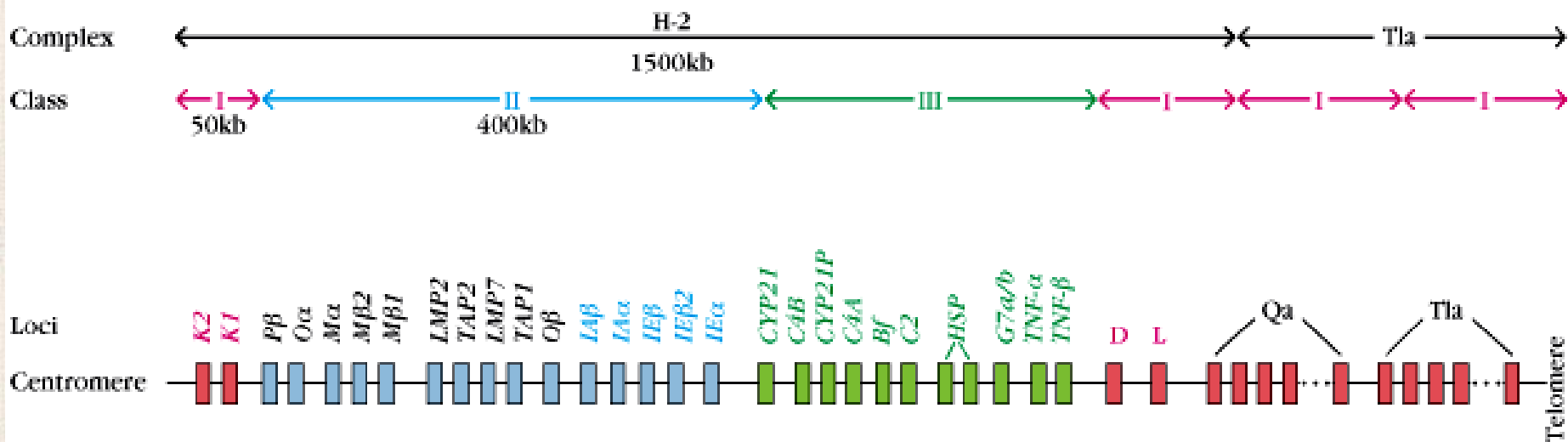

HUMAN CHROMOSOME 6

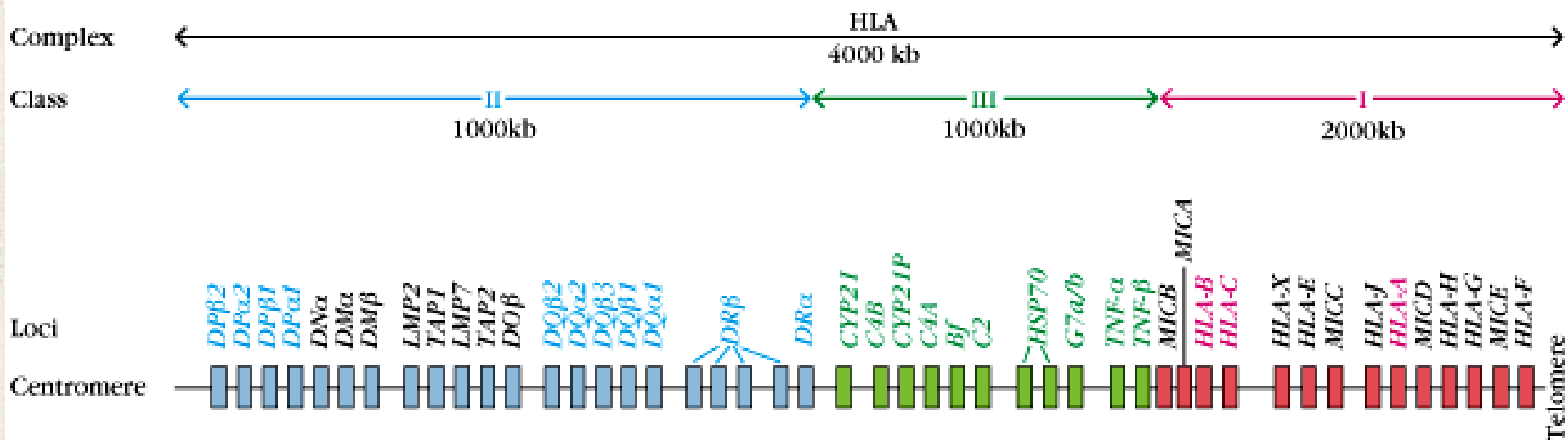

HLA map

Chromosome 6

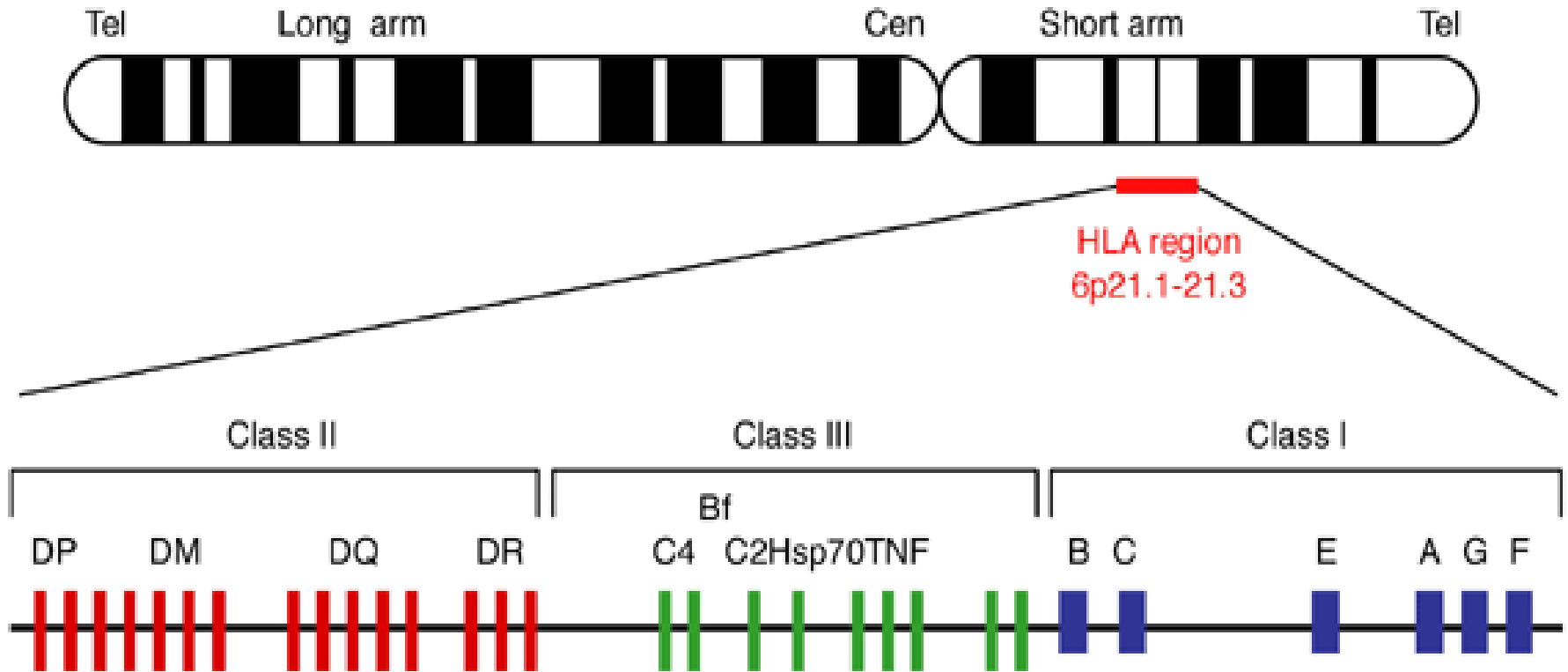

Gene map of the human leukocyte antigen (HLA) region

Expert Reviews in Molecular Medicine © 2003 Cambridge University Press

The MHC is **polygenic** (there are *several* different class I and class II ***genes*** encoding proteins with different specificities) and highly **polymorphic** (there are ***multiple alleles of each gene***) that most individuals are likely to be heterozygous at each locus. Alleles are expressed from both MHC haplotypes in any one individual (**co-dominant**), and the products of all alleles are found on all expressing cells.

In human there are three classical class I molecules (**HLA-A, B, C**) and three classical class II molecules (**HLA-DR, DP, DQ**). The HLA-A has more than 20, B has more 50, and C more than 10 alleles. HLA-DR has 20, HLA-DQ has 9, and HLA-DP has 6 alleles.

Antigen processing and presentation on MHC Class I

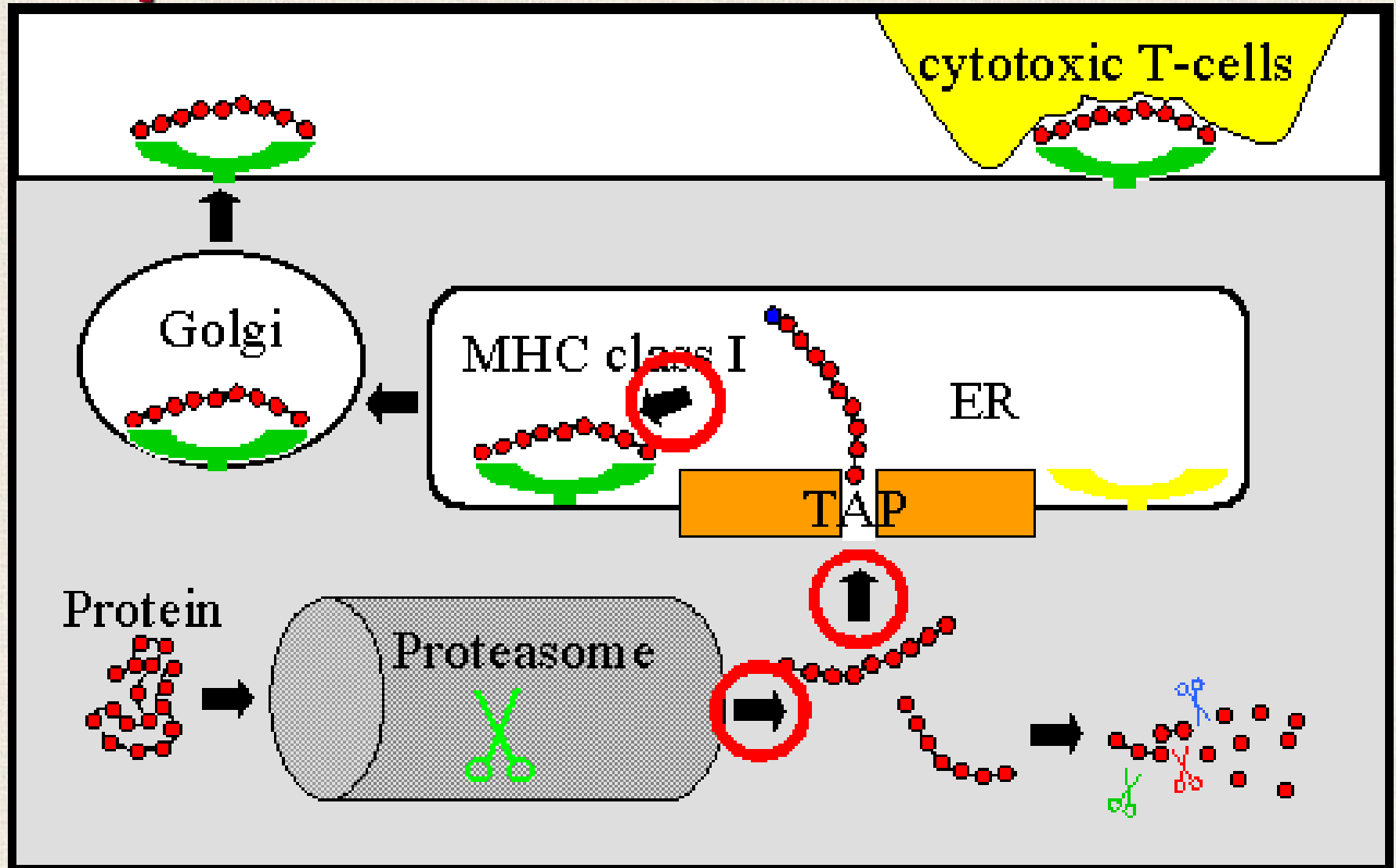

Transporter Associated with Antigen Processing

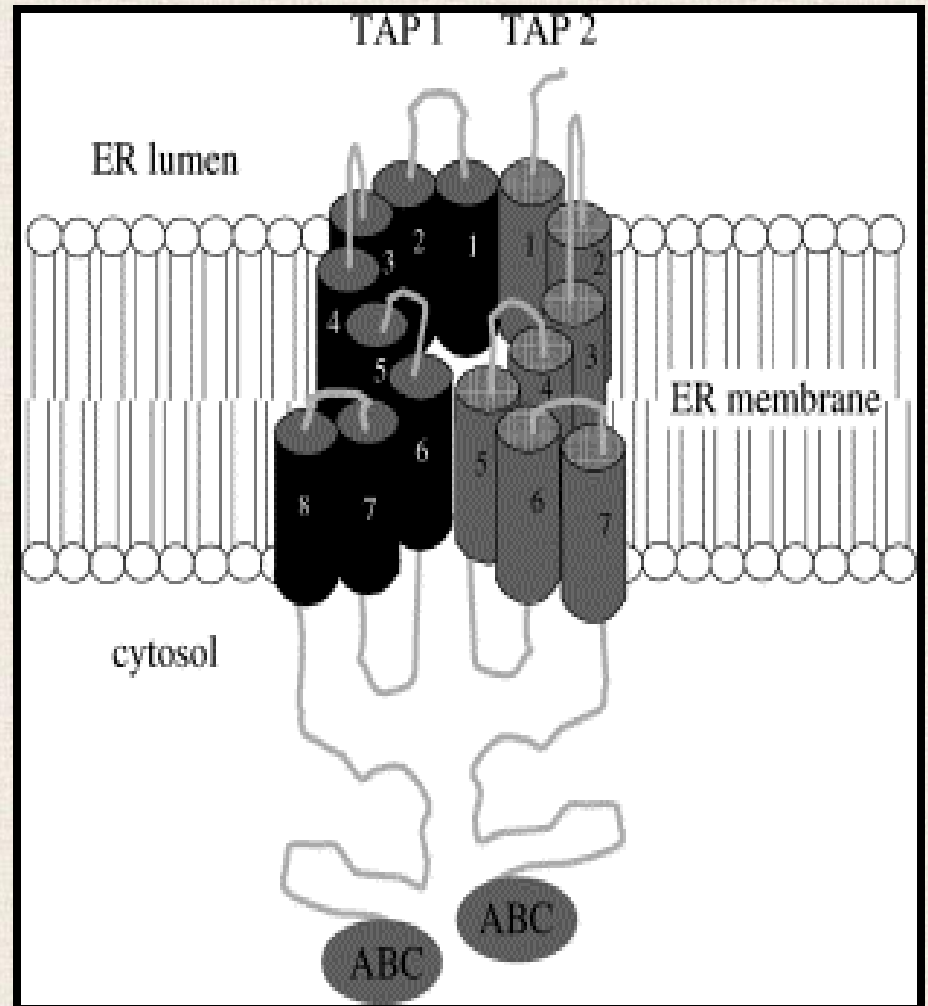
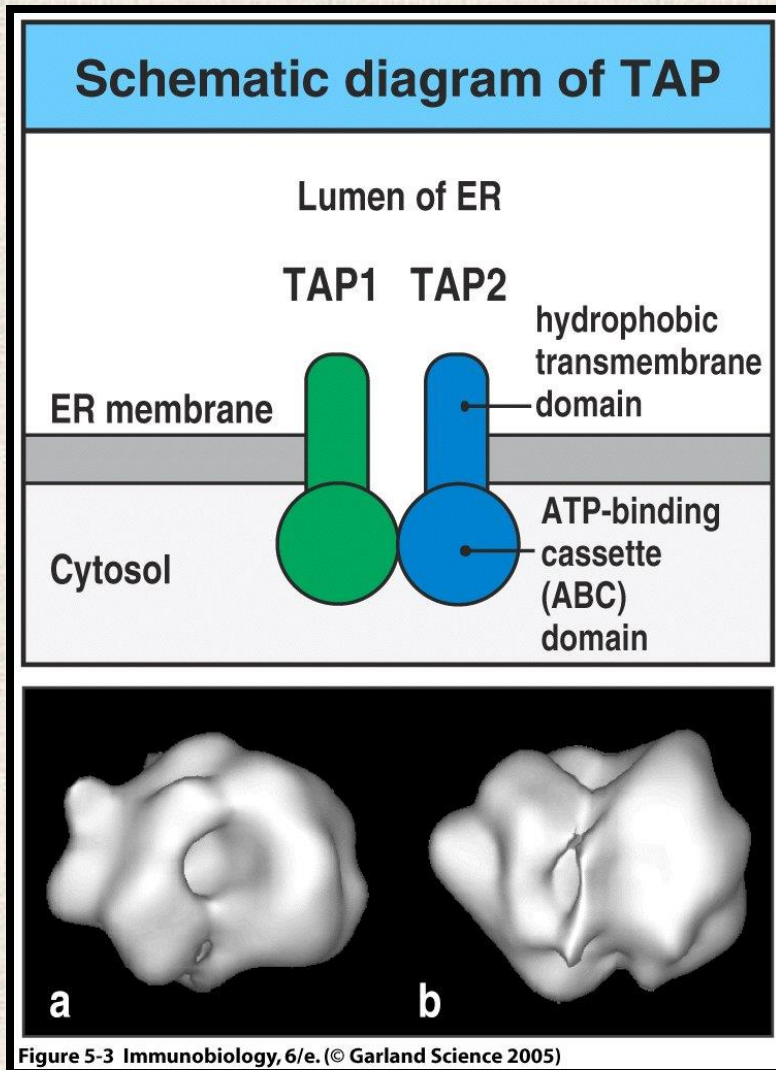

Figure 5-3 Immunobiology, 6/e. (© Garland Science 2005)

Chaperons in the MHC Class I antigen presentation

Calnexin, calreticulin, Erp57, tapasin

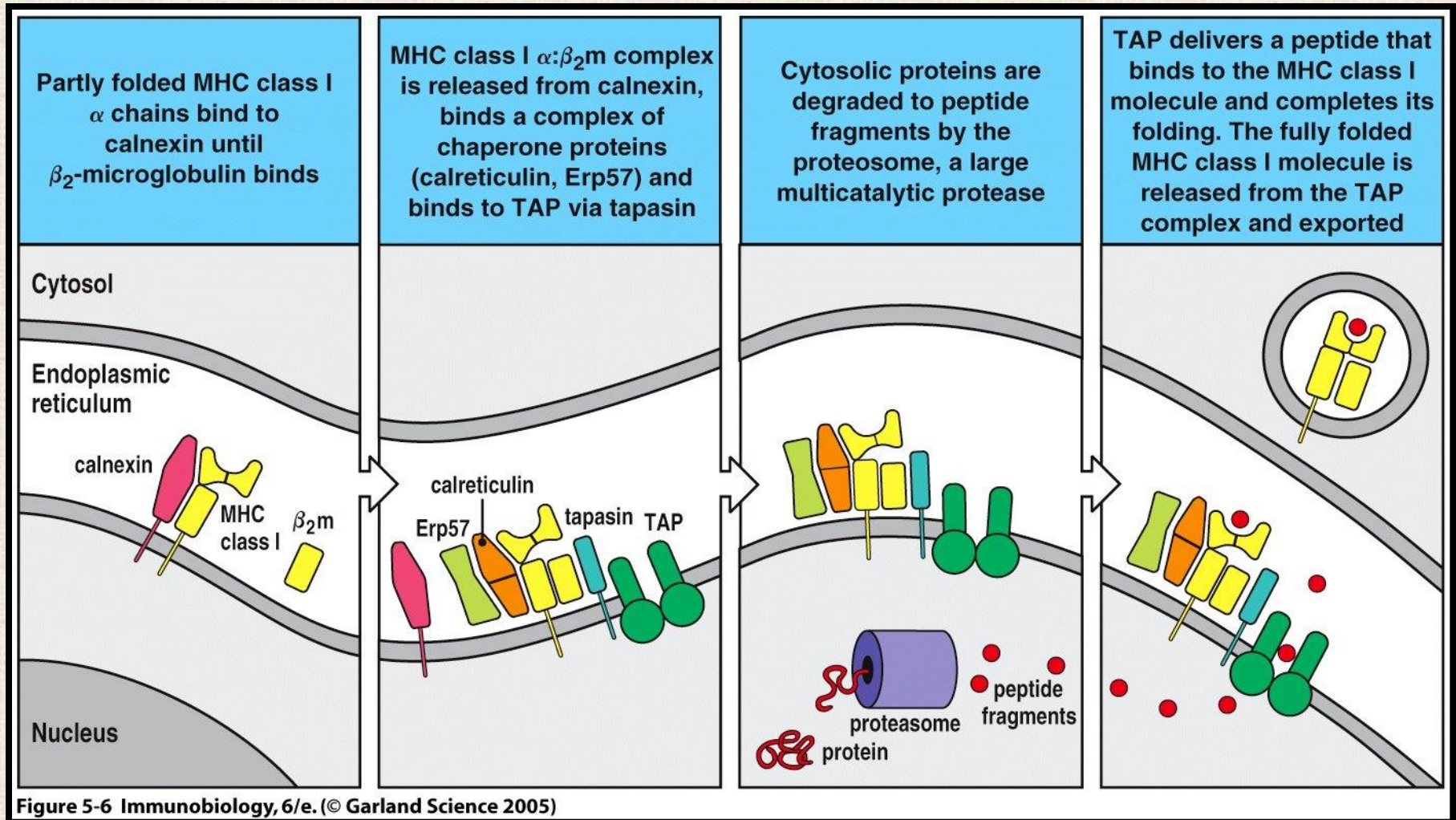
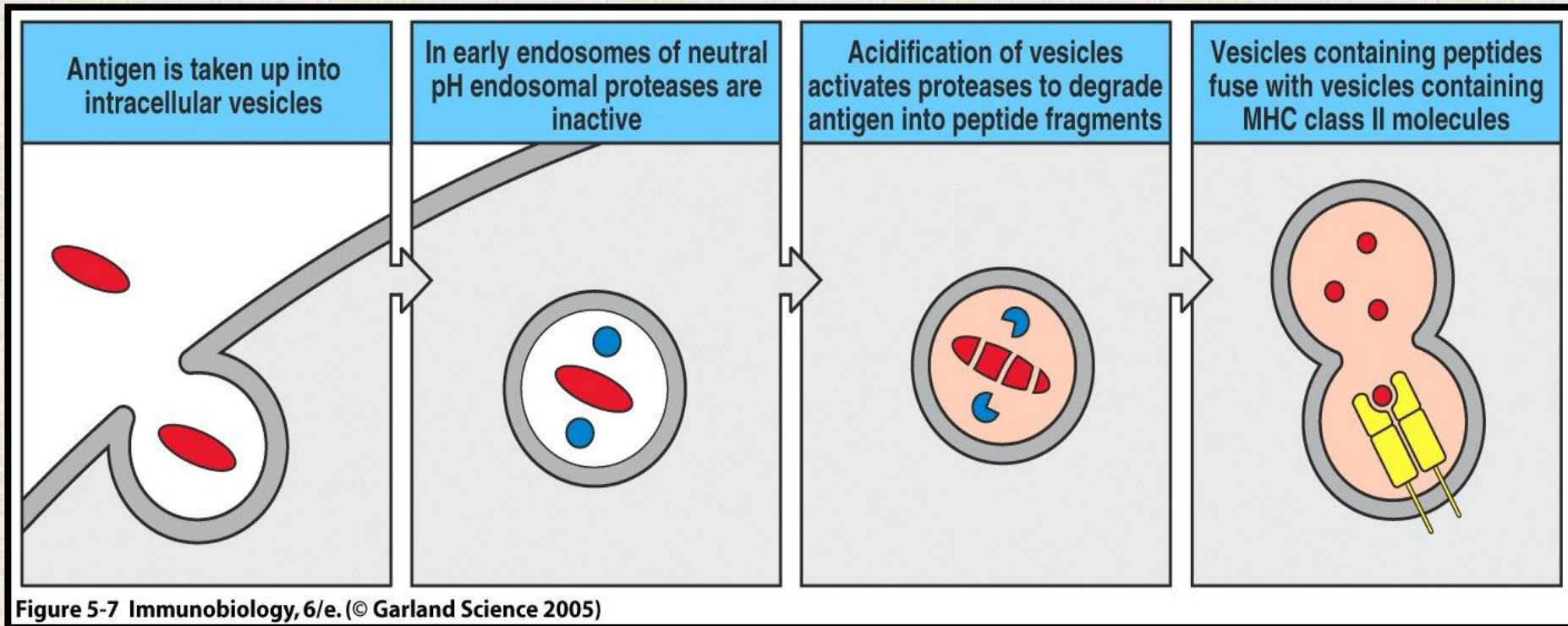
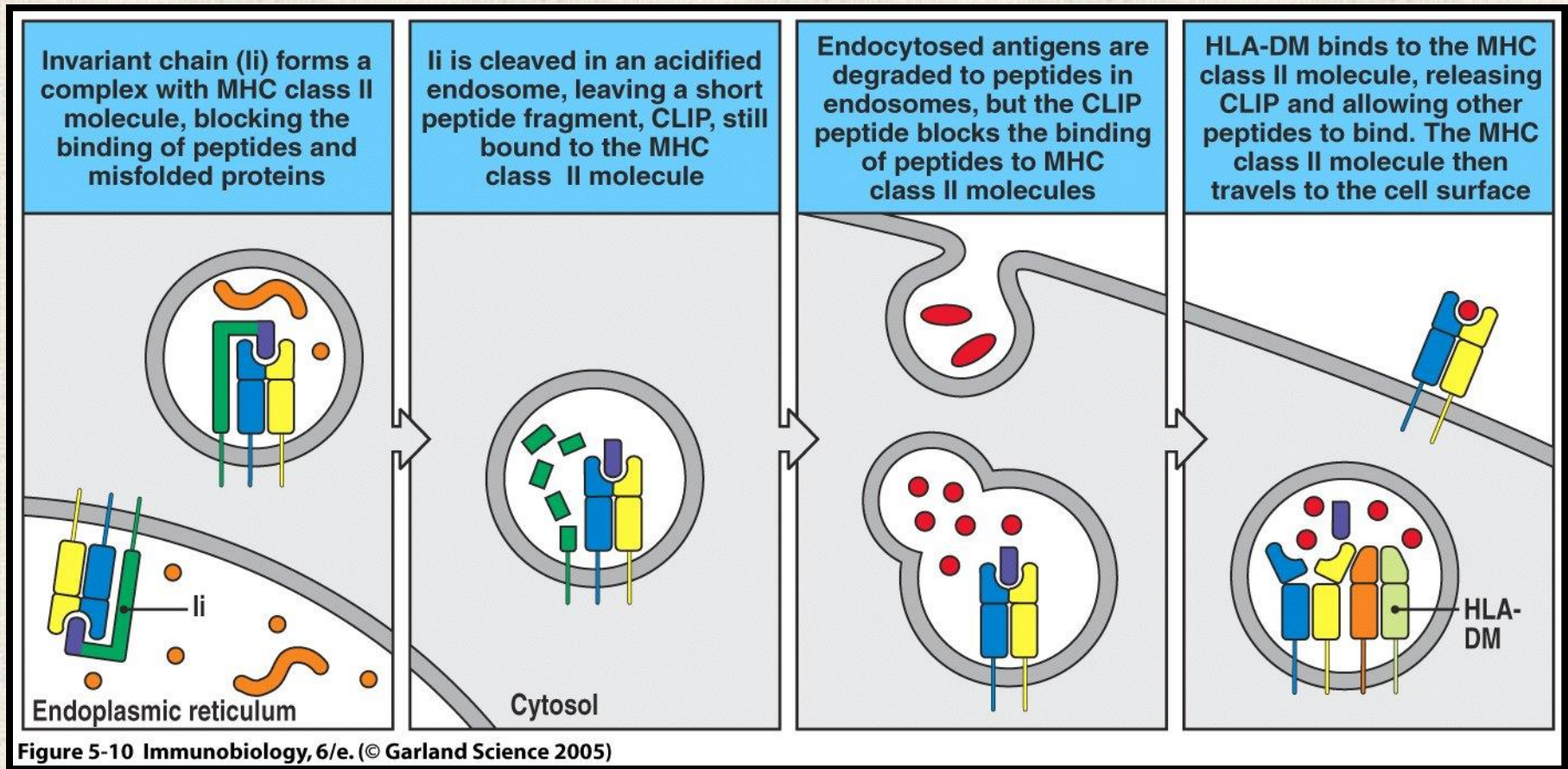

Figure 5-6 Immunobiology, 6/e. (© Garland Science 2005)

Generation of antigenic peptides in the endocytic pathway for presentation by MHC II



Peptide loading of MHC Class II molecules



HLA-DM: MHCII chaperon

CLIP=class II associated invariant chain peptide

**Presentation
of
intracellular
antigens by
MHC I:
continuous in
all cells and
platelets**

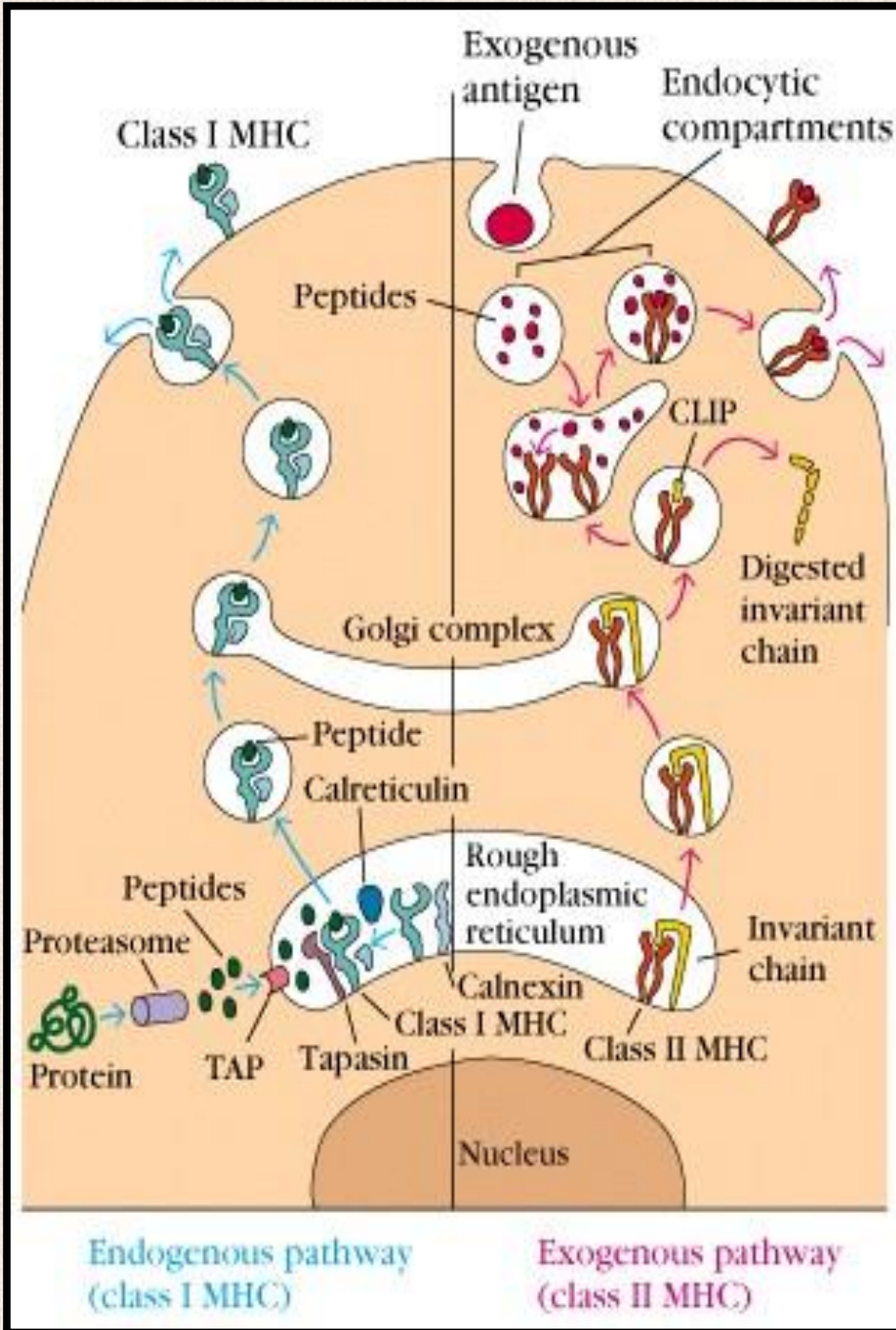

**Presentation
of
extracellular
antigens by
MHC II:
in APCs,
after
phagocytosis**

Endogenous pathway
(class I MHC)

Exogenous pathway
(class II MHC)

MHC Restriction

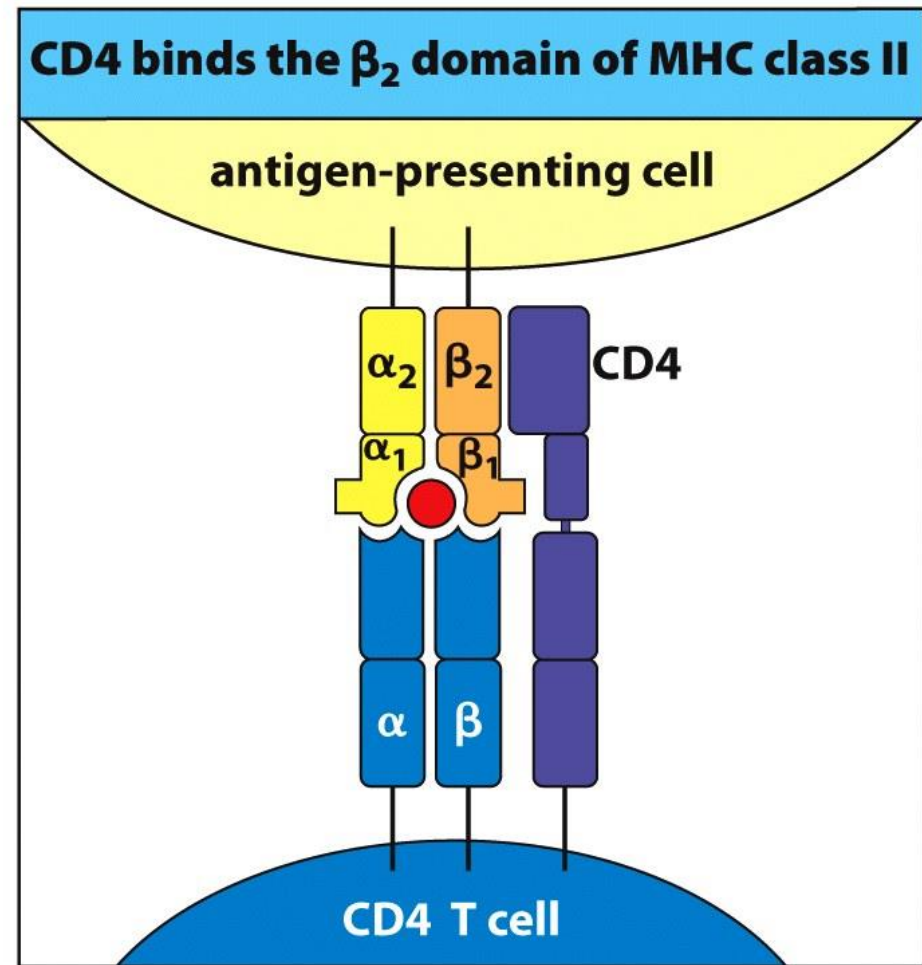
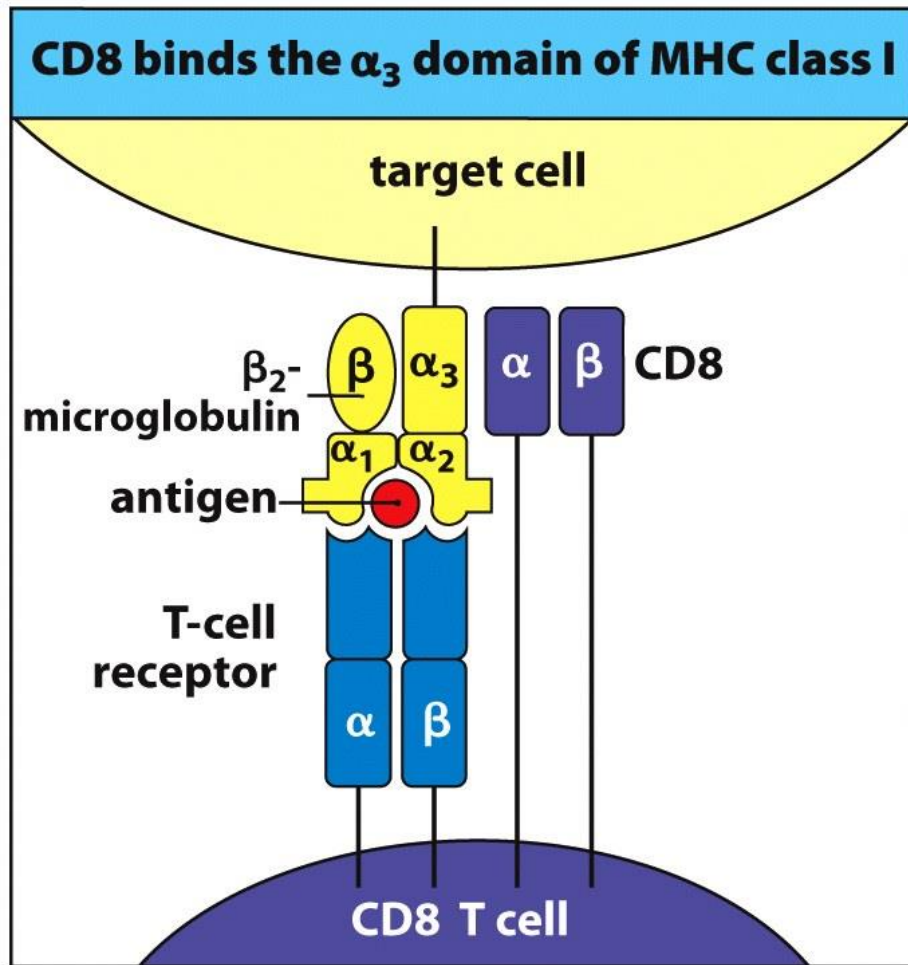

Figure 5.14 The Immune System, 3ed. (© Garland Science 2009)

MHC I – CD8

MHC II – CD4

How do pathogens avoid detection?

MHC-I

Herpes simplex – produces a protein which inhibits TAP

Adenovirus – produces a protein, which binds to and retains MHC-I in the ER

Cytomegalovirus – accelerates MHC-I translocation to the cytosol for degradation

HIV – accumulate mutations faster than the adaptive immune system can cope with

MHC-II

Helicobacter pylori – encodes a 95kD protein toxin, which increases the pH of the lysosomes, inhibiting protease activity

Septicemia (toxic shock syndrome) caused by superantigens

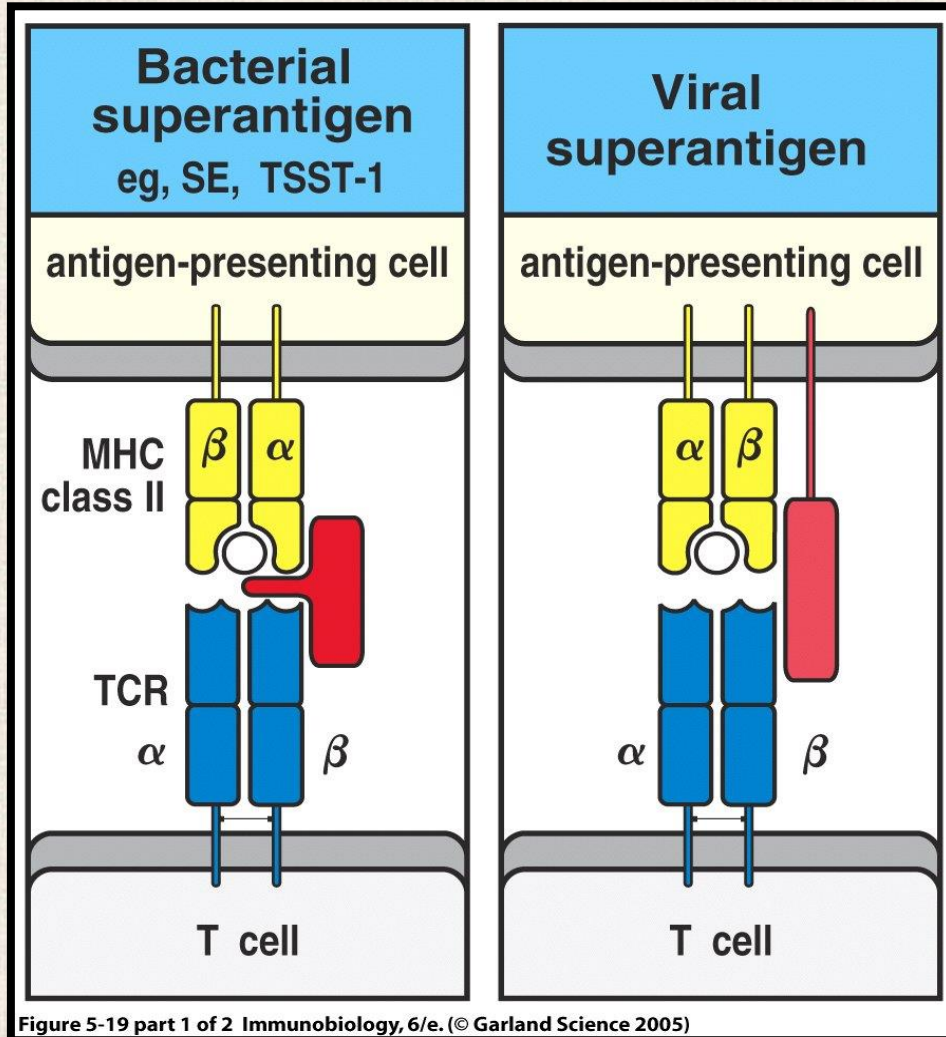

Compared to a normal antigen-induced T-cell response the endotoxins (Sags) are capable of activating much higher number of the T-cells in nonspecific manner. This causes a massive immune response with irregular cytokine production (toxic shock syndrome) that is not specific to any epitope on the SAg.

T cells activated nonspecifically overproduce cytokines resulting systemic toxicity with general catastrophe of bioregulation, („Cytokine tsunami”)

Definition of Toxic Shock Syndrome (septicemia, blood-poisoning)

Toxic shock syndrome (septicemia/blood-poisoning) is a life-threatening complication of certain types of bacterial or viral infections. Often toxic shock syndrome results from toxins produced by *Staphylococcus aureus* and *group A Streptococcus* bacteria, or some viral toxins (SARS-CoV-2). First description of toxic shock syndrome has been associated primarily with the use of superabsorbent tampons, but risk factors now include skin wounds and surgery. Physiological T cell activation is antigen-specific and well controlled, however, the T cell activation in toxic shock syndrome is none-specific and irregular. Clinical symptoms caused by irregular and mass production of cytokines („cytokine-tsunami”).